



Sign No. 6 Vehicular - Directional

Sheet List	
Sheet Number	Sheet Name
01	title sheet and drawing list
02	typography, colours and pictograms
03	sign design - overview
04	sign design - graphic design details
05	sign construction - sections
06	sign construction - details
07	general notes

project: Campus Wayfinding
 number: FM 09-8567
 issue date: Jan 31, 2012

sign: Sign No. 6 - Directional
 sheet name: title sheet and drawing list
 scale: as noted

sheet
number:

01



**University
of Victoria**

core colours



clear anodized coating
application: sign structure

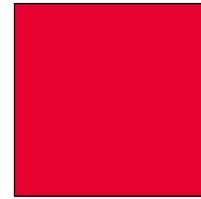

PANTONE 185 C
application:
pinstrip, arrows



PANTONE 426 C
application: text,
crest - monochromatic

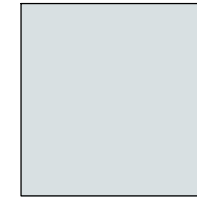

PANTONE 7541 C
application: background,
back panel (single sided sign)
crest - reversed monochromatic

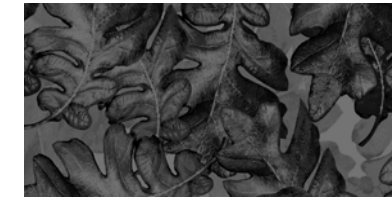

gary oak motif - digital file is to be delivered
by University of Victoria

samples of typeface family

Myriad Pro Semi Bold

ABCDEFGHIJKLMNOPQRSTUVWXYZ

abcdefghijklmnopqrstuvwxyz

1234567890

arrow style and arrow size in relation to text height

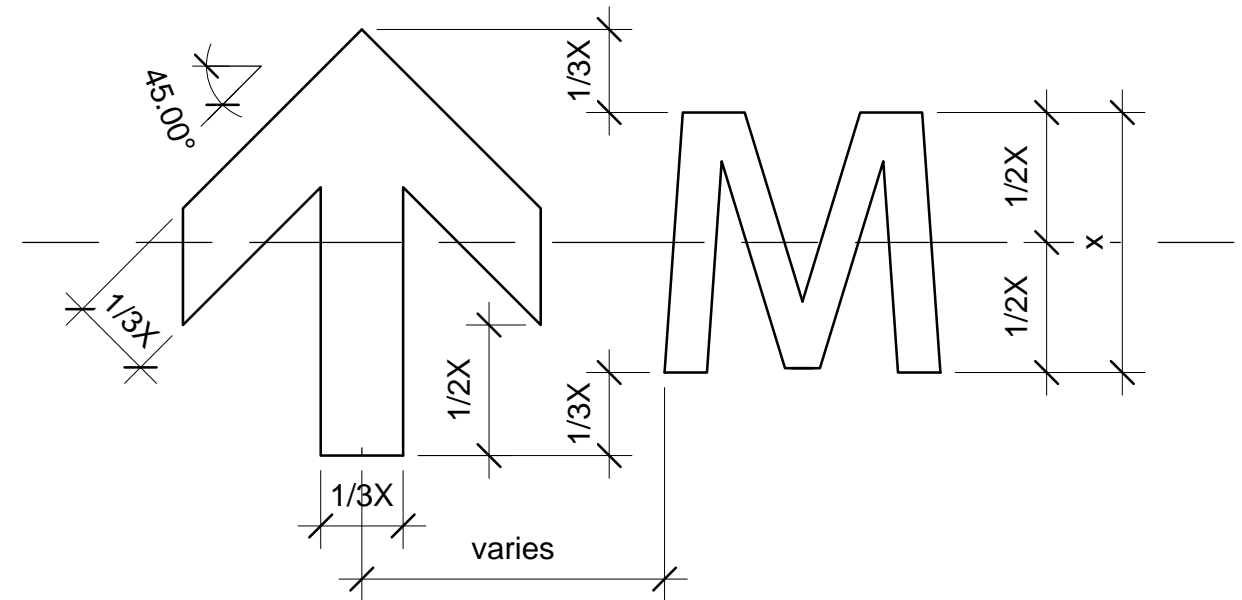

University of Victoria Logo, horizontal standard



University
of Victoria

full colour



University
of Victoria

opaque monochromatic



University
of Victoria

opaque monochromatic reversed



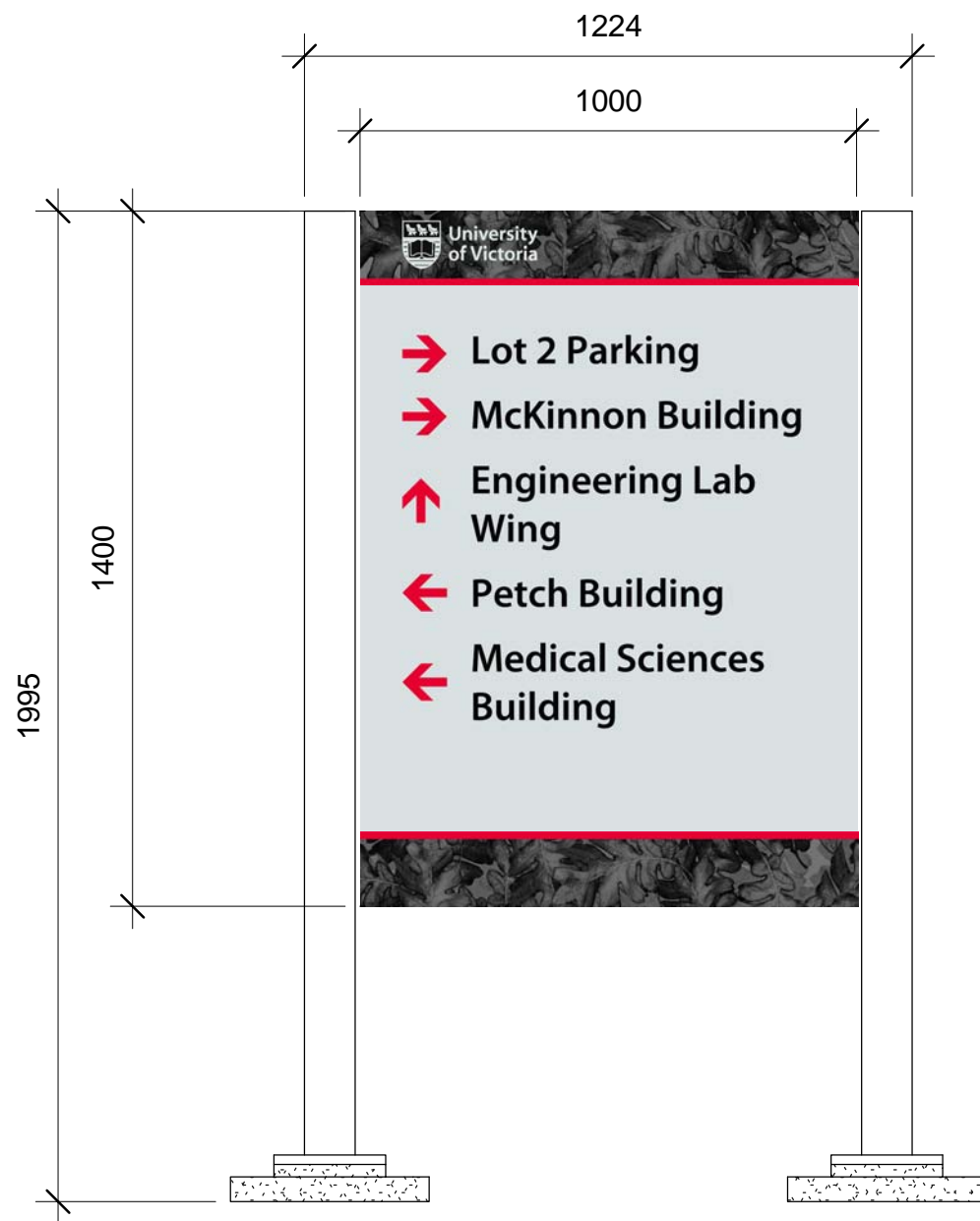

Directional version 1
scale 1:15

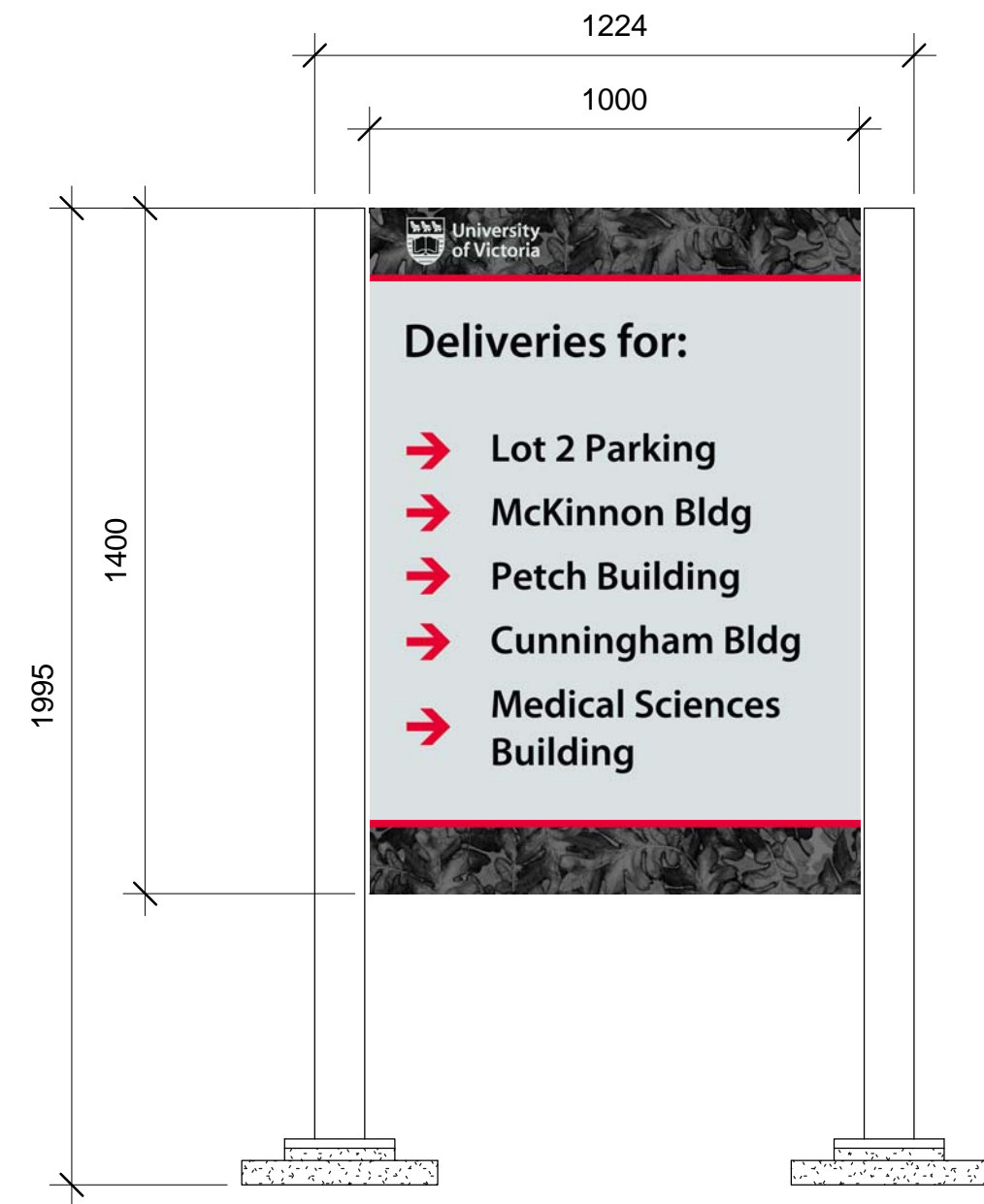

Directional version 2
scale 1:15

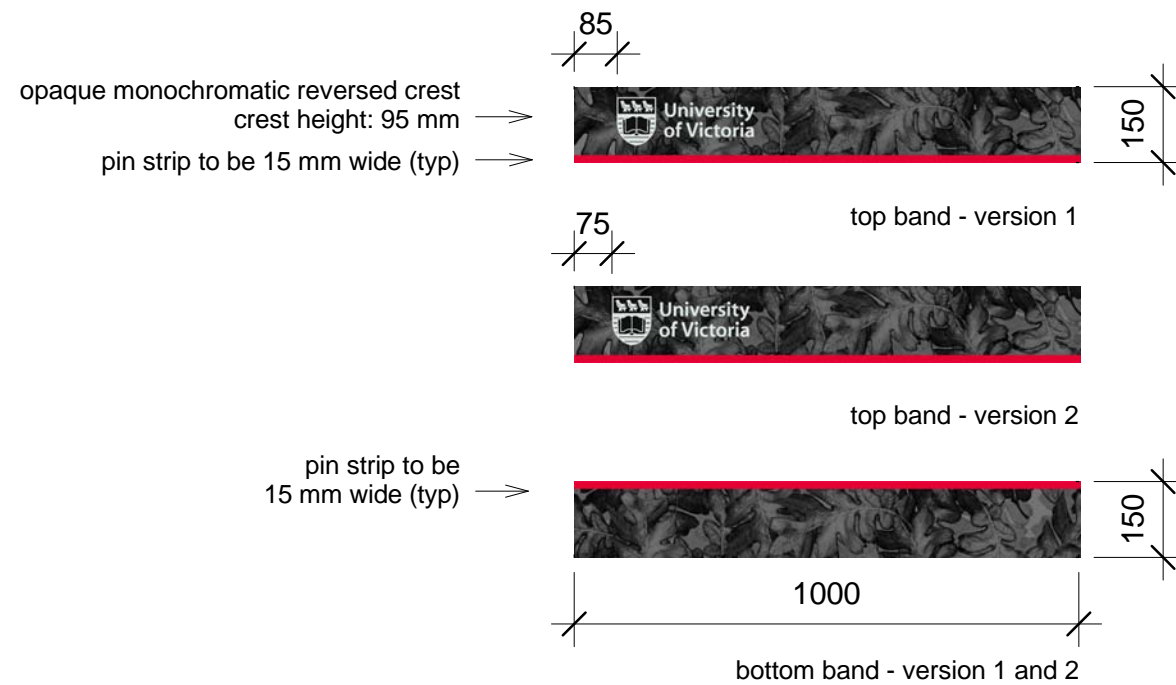

Description
Digitally printed vinyl protected with anti-graffiti, optically clear overlamine
Aluminum panel size (one piece): 1000 mm x 1400 mm x 6.4 mm
See sheet 05 for details.

Vinyl: 3M IJ180, MPI 2005 or equivalent
Overlamine: 3M 8914, Avery DOL 6060 or equivalent.

- 1) One piece vinyl to be printed on, installed as per manufacturer's recommendations.
- 2) Use compatible UV inks and overlamines as recommended by manufacturer
- 3) Wrap vinyl and overlamine over the edges of the aluminum panel.
- 4) If single sided sign then back panel to receive vinyl printed with PANTEONE 7541 C

Refer to Adobe Photoshop files for detailed sample layout

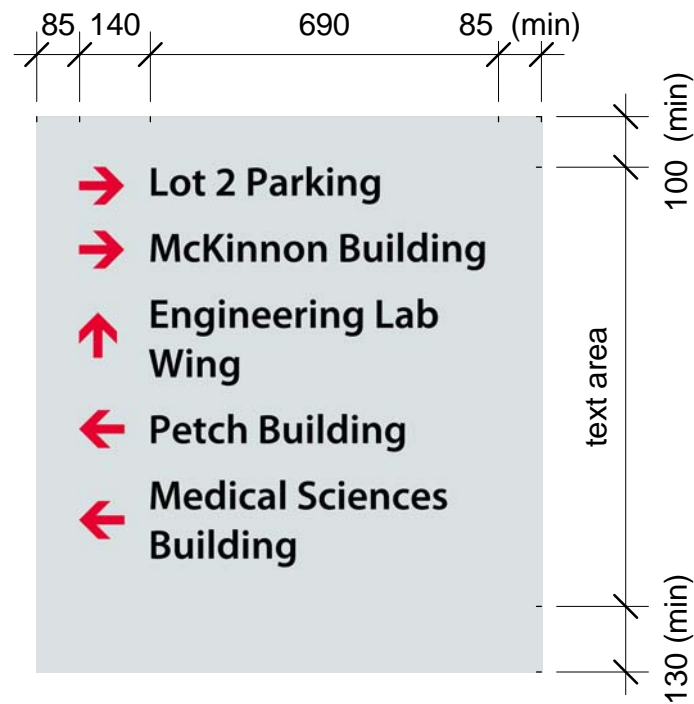

version 1

type size: 275pt →

type size: 230pt
leading: 370pt →

double line stacked
type size: 230pt
leading: Auto →

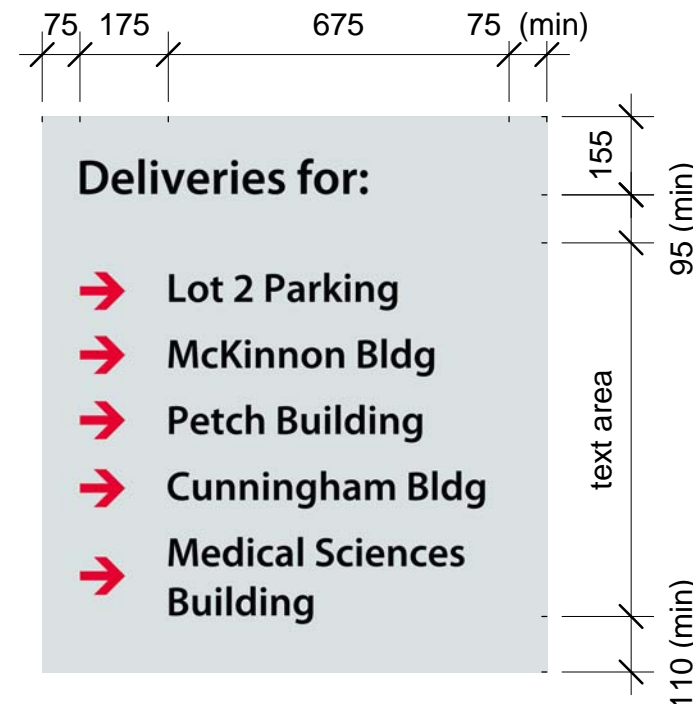

version 2

scale 1:15

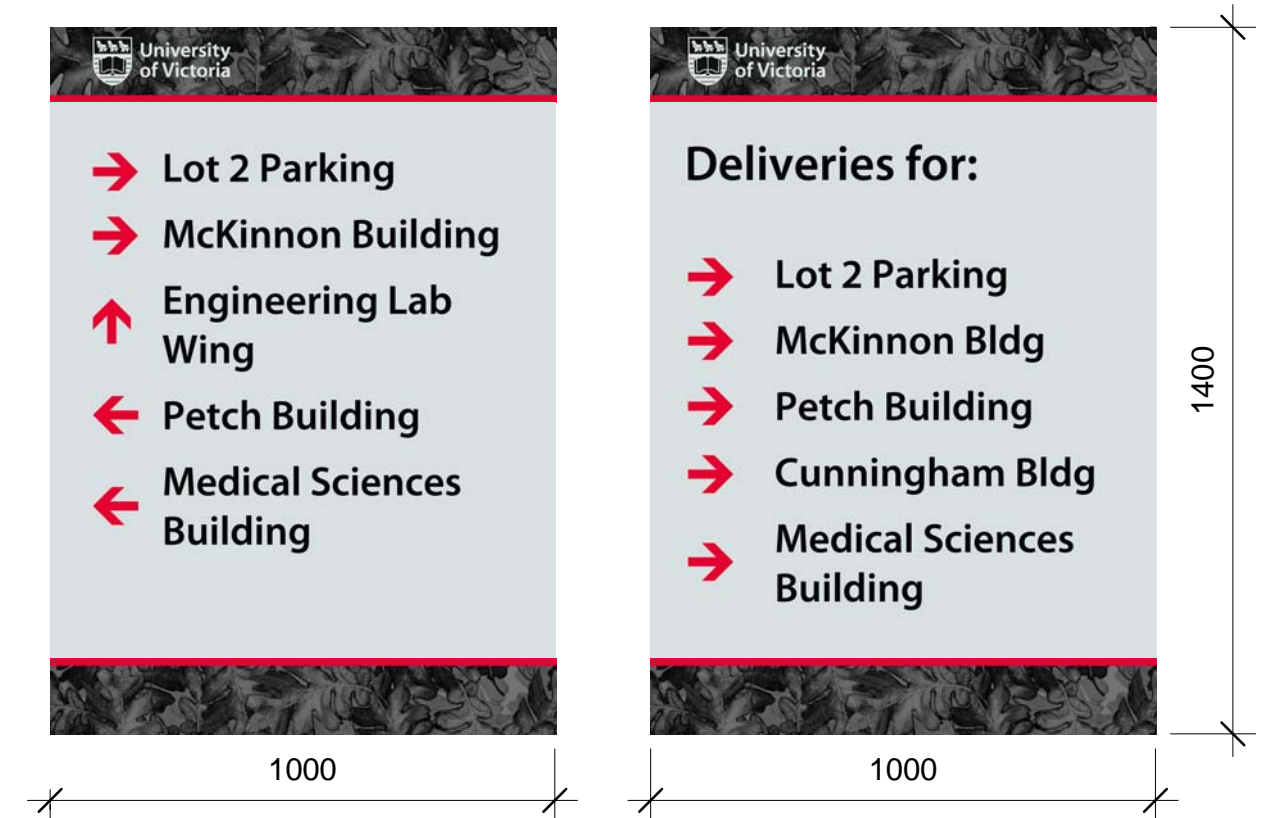

version 1

version 2

scale 1:15



project: Campus Wayfinding
 number: FM 09-8567
 issue date: Jan 31, 2012

sign: Sign No. 6 - Directional
 sheet name: sign construction - sections
 scale: as noted

sheet number:

05

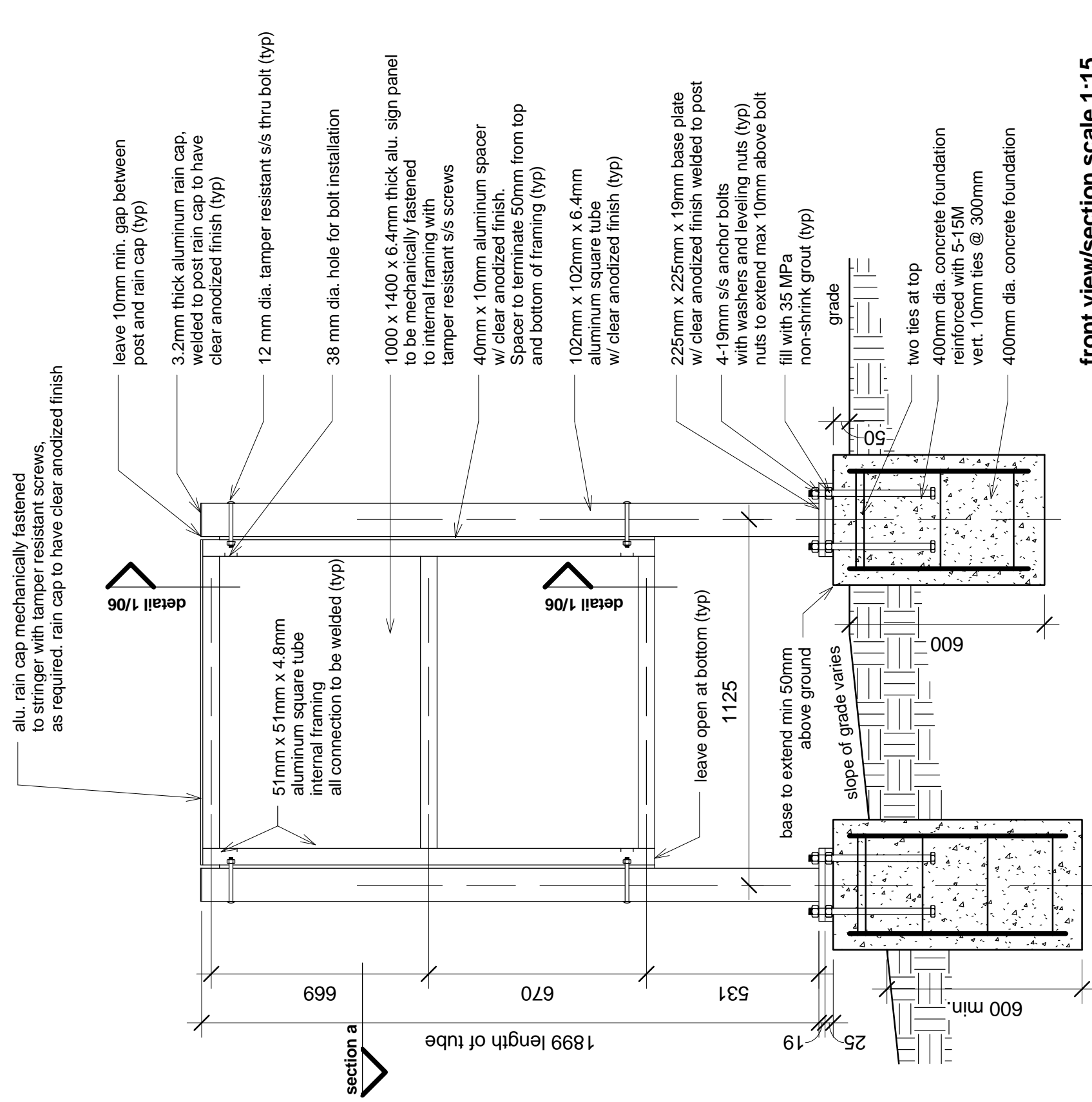

front view/section scale 1:15

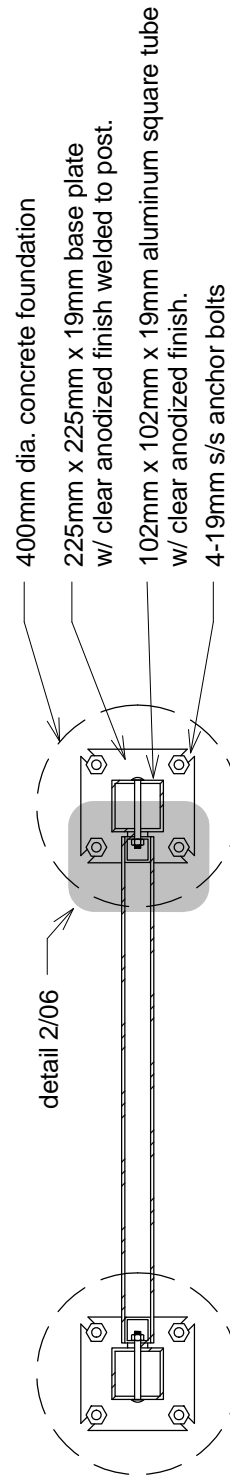

section a scale 1:15

General Note:
 Manufacturer to verify all dimensions
 prior to sign fabrication. All discrepancies
 should be reported to the Architect.



University
 of Victoria

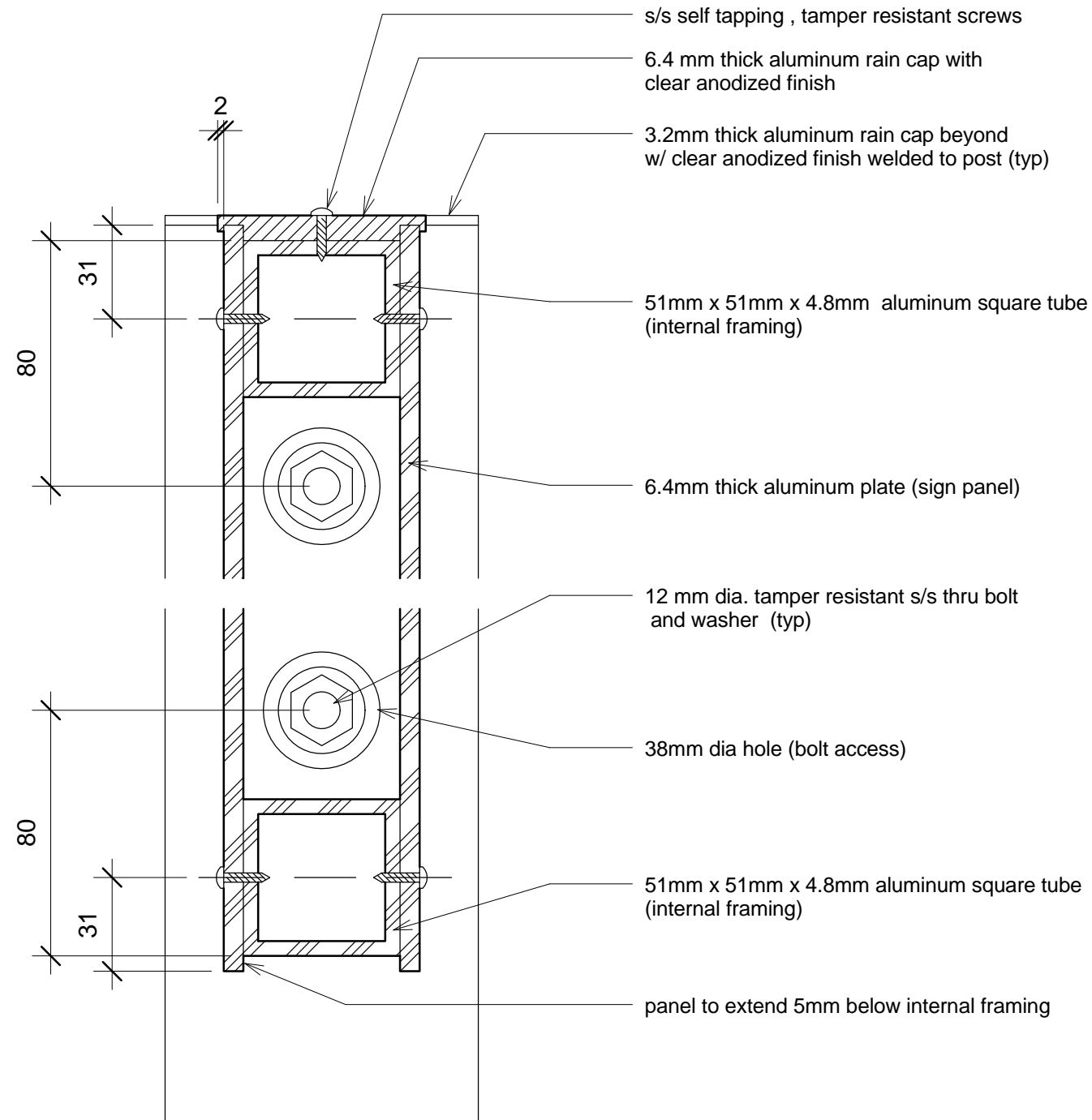

General Note:
 Manufacturer to verify all diemnsions prior to sign fabrication. All discrepancies should be reported to the Architect.

section detail 1 scale 1:2

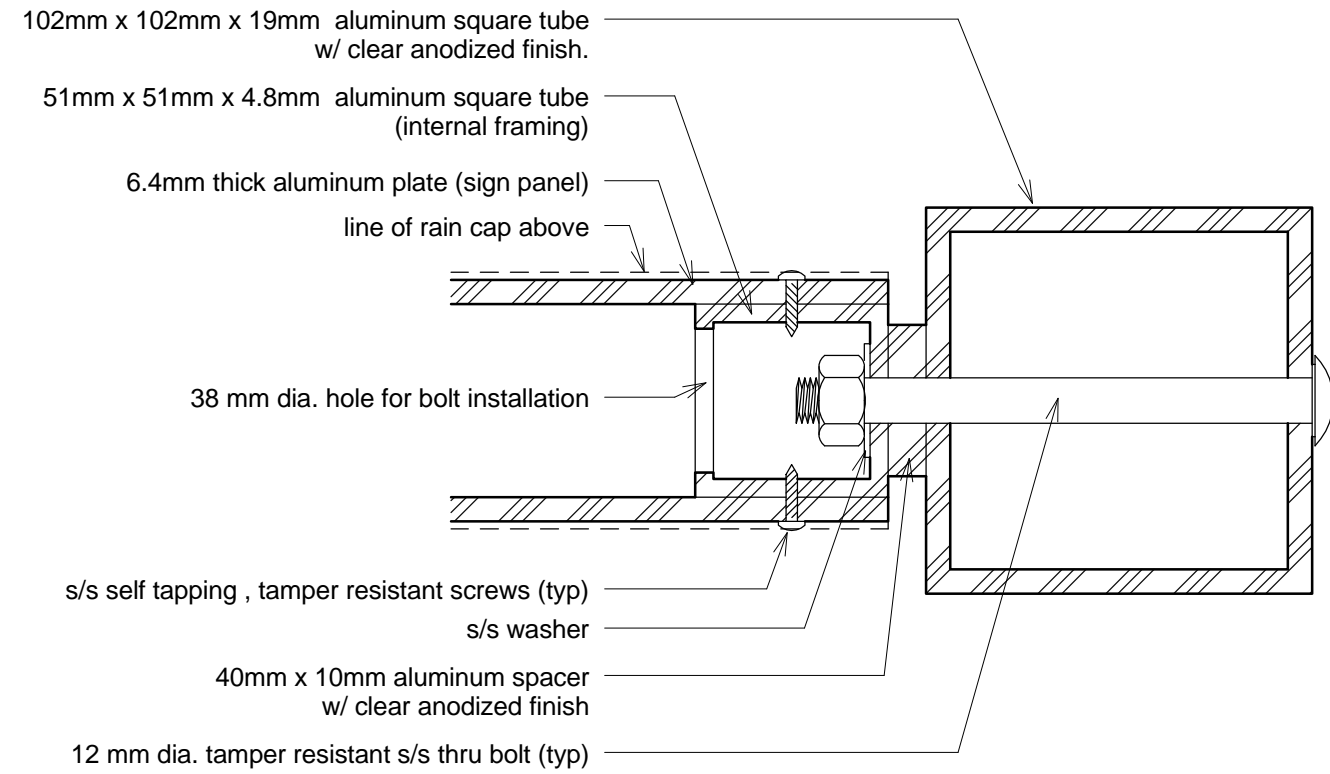

section detail 2 scale 1:2

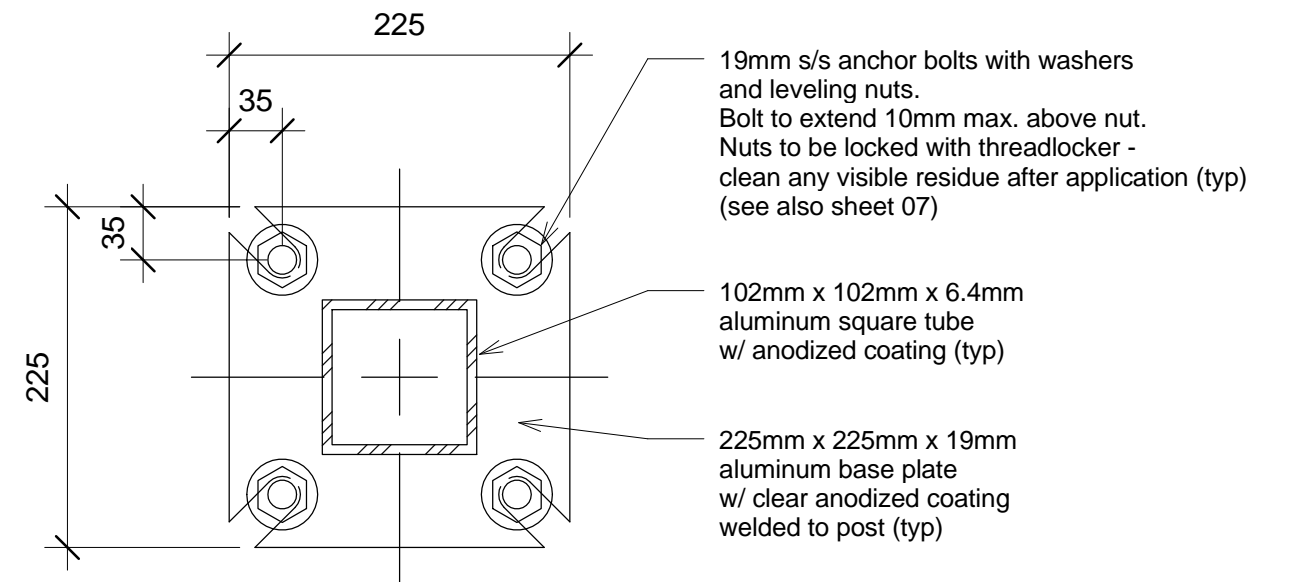

section b (slip base) scale 1:5

GENERAL NOTES

1. Provide self adhesive sign ID stickers. ID's should correspond with ID's shown on location plan Form and placement of stickers on signs is to be coordinated with University of Victoria
2. Fasteners:
 - foundation (anchor bolts):
 - bolts: Fastenal part #47406 (1/2" s/s threaded rod)
 - washers: Fastenal part #71021 (1/2" s/s washers)
 - nuts: Fastenal part #70714 (1/2" s/s nuts)
 - posts:
 - thru bolts: Fastenal part #174786 (1/2" s/s x 5" button Socket Cap Screw)
 - thru bolt washers: Fastenal part #71021 (1/2" s/s washers)
 - thru bolt nuts: 70714 (1/2" s/s nuts)
 - panels:
 - security screws panel attachment: Fastenal part #BS0160024SSH200 (10-24 x 3/4" button head security screw)
 - rain cap attachment: Fastenal part #BS0160024SSH200 (10-24 x 3/4" button head security screw)
3. Threadlocker: Locktite 271 Red
4. Whenever anchor bolts are cut, contractor to ensure cut surfaces (terminated coating) are protected against rusting.
5. Manufacturer to verify all diemnsions prior to sign fabrication. All discrepancies should be reported to the Architect.

STRUCTURAL NOTES

DRAWINGS

1. These drawings show the completed project. The drawings do not show components that may be necessary for construction safety, which is the responsibility of the contractor.
2. The use of these drawings is limited to that indicated in the revisions column.
3. The information on these drawings shall not be used for any other project or works.

DESIGN

1. The structures shown have been designed in substantial accordance with the British Columbia Building Code 2006, which is based on the National Building Code of Canada 2005.
2. The following wind loads and factors were used: $q_{50}=0.63\text{kPa}$, $I_w=1.0\text{-ULS}$, 0.75-SLS .

FIELD REVIEW BY STRUCTURAL ENGINEER

1. Structural Engineer provides field review only for the work shown on these structural drawings, and it is conducted with such frequency as Structural Engineer deems appropriate to ascertain that the work is in general conformance with the documents prepared by Structural Engineer.
Field review by Structural Engineer is not carried out for the Contractor's benefit, nor does it make Structural Engineer guarantors of the Contractor's work. It remains the Contractor's responsibility to build the work in conformance with the contract documents. Structural Engineer shall not be responsible for the acts or omissions of the Contractor, Sub-Contractor, or any other persons performing any of the work or for the failure of any of them to carry out the work in accordance with the contract documents.
2. Provide 24 hours advance notice of each required field review. Field reviews shall be scheduled to be carried out during normal business hours unless special arrangements are made with Structural Engineer.
3. The work to be reviewed shall be generally complete.

STRUCTURAL NOTES (cont)

CONCRETE AND REINFORCING STEEL

1. Concrete work shall conform to CAN/CSA-A23.1, CAN/CSA -A23.2, CAN/CSA -A23.3 and referenced documents.
2. Reinforcing shall conform to CAN/CSA-G30.18R – Grade 400MPa.
3. Cover to reinforcing steel to be 50mm uno.
4. Portland cement shall be type gu unless noted otherwise.
5. Concrete shall have a unit weight of $23\pm 1\text{ kn/m}^3$ ($145\pm 5\text{ pcf}$) unless noted otherwise.
6. Concrete shall have a compressive strength of 35MPa at 28 days, and conform to exposure class C-1 with a maximum water-cement ratio of 0.40 and air content of 5-8%. Maximum aggregate size to be 19mm.
7. No calcium chloride is permitted, in any form, in any concrete mix. Curing and protection of concrete for hot, cold or dry weather is to be as per clauses 7.4.1.8 and 7.4.2 of CAN/CSA.

STRUCTURAL ALUMINUM

1. Aluminum sections shall be new.
2. Aluminum alloys shall conform to the Aluminum Association publication Aluminum Standards and Data ISO 6361-2 or ISO 6362-2.
3. Extruded shapes, Tubes, Bolts, and Plate to be 6061 alloy uno.
4. Aluminum in contact with concrete or grout shall be given a heavy coat of alkali-resistant bituminous paint or other equivalent coating before installation.
5. Welding operators and procedures shall be qualified according to CSA W47.2.
6. Submit shop drawings for review prior to start of steel fabrication.
7. Fabrication practices and tolerances shall be in accordance with CAN/CSA-S16, except bolt holed edge distance tolerance to be -0, +2mm.
8. Anchor and connection bolts to be ASTM A193 Stainless Steel. Anchors shall be embedded 300mm into concrete, complete with a nut and washer each end.
9. Unless noted otherwise, column base plates shall be 20 mm minimum thick. Anchor bolt holes shall be punched undersize and reamed to size.
10. Provide 6 mm cap plates for all tube members uno.
11. Aluminum shall be connected with fillet welds all-around uno. Weld size shall match the wall thickness of the thinnest part being connected uno. Welds to be ground smooth.

TAMPER RESISTANCE AND CONNECTIONS

1. Connection hardware to be stainless steel uno.
2. Aluminum panels to be connected to structure with 6.4mm diameter stainless steel self-tapping screws at 450mm maximum centre to centre spacing.
3. Non-removable panels may be welded or glued by the manufacturer, as approved by Structural Engineer.
4. Panel connection screws to be tamper resistant "Torx-Pin" screws as supplied by O.E.M. Hardware of Surrey BC, or equivalent as approved by Structural Engineer.
5. Visible connection bolts shall be "Pentagon" tamper resistant bolts, with "Pentagon" nuts as supplied by O.E.M. Hardware of Surrey BC, or equivalent as approved by Structural Engineer. Anchor bolts to be secured with "Pentagon" security nuts.

project: Campus Wayfinding
number: FM 09-8567
issue date: Jan 31, 2012

sign: Sign No. 6 - Directional
sheet name: general notes
scale: as noted

sheet
number:

07



**University
of Victoria**