

Operating and
Maintenance Manual
for

RiOs™ and Elix®

water purification systems

NOTE

Information in this document is subject to change without notice and should not be construed as a commitment by Millipore Corporation. Millipore Corporation assumes no responsibility for any errors that may appear in this document. This manual is believed to be complete and accurate at the time of publication. In no event shall Millipore Corporation be liable for incidental or consequential damages in connection with or arising from the use of this manual.

Copyright

Copyright © 2002, all rights reserved, Millipore Corporation.

Folder: PF07551

Documentation: PF05113, Rev 7, 01/06

Trademarks

Millipore is a registered trademark of Millipore Corporation.

Elix and Milli-Q are a registered trademarks of Millipore Corporation.

RiOs, Progard and RoClean are trademarks of Millipore Corporation.

Teflon is a registered trademark of E.I. duPont de Nemours & Co.

All other trademarks are trademarks of their respective manufacturer.

Table of contents

Use of this manual	5
INTRODUCTION	6
General Information	6
Operating principle	6
Flow schematic	7
Specifications	8
INSTALLATION	11
Unpacking	11
Installation of the system	11
Installation	12
OPERATION	14
Operating modes	14
Routine displays	14
Additional displays	15
Use of the keypad	17
Start up of the system	19
Installation of the standard reservoir from Millipore	22
MAINTENANCE	23
Routine maintenance	23
Periodic maintenance	23
MAINTENANCE	26
Maintenance Messages	26
Error codes	27
APPENDIX 1	28
Feed water conductivity measurement	28
Pressure regulator adjustment verification	28
Prolonged shutdown of the system	28
System information N°	29
APPENDIX 2 (Information exclusively for the attention of Millipore service personnel)	30
Replacement of the reverse osmosis cartridge(s)	30
Start up of a Progard pretreatment pack of a different size	30
Interruption of a cleaning or rinsing cycle on the RO cartridge(s)	31
Replacement of main electrical power fuse	31
APPENDIX 3	32
Additional features (UV lamp)	32
INDEX	34
ORDERING INFORMATION	35

Table of contents (cont'd)

WARRANTY 37

TECHNICAL INFORMATION

Contacting Millipore 38

At back of document

FIGURES

Use of this manual

This document describes how to install, use, and carry out the maintenance of your water purification system. The operation of the system is very simple; however we do recommend that you read this document completely and carefully before making water and electrical power connections. Knowing your system well, not only avoids possible damage to the system on start up, but also familiarizes you with all its functions.

Warning symbols

The information contained in this manual is set out in the following manner.

The 7 types of systems in the RiOs/Elix range are all described together in this manual. The guide which is located either at the left or right of each page allows you to see which information is specific to one type of system. This is seen by verifying that the column corresponding to your system is full before reading a paragraph, characteristic, etc...

Example:

FOR A COMMON TEXT : All columns are full.

FOR TEXT SPECIFIC TO
Elix SYSTEMS : The three last columns are full.

The drawings are grouped at the back of this manual on fold out sheets.

The items drawn in dotted lines represent elements not supplied with the system. The items shown in light grey, represent the keypad buttons which are not referred to in the paragraph in question, or represent information displayed on the screen by way of example.

Warnings

The "warning" symbols are shown to draw your attention to actions where a risk of damage or possible injury occurs.



: **Attention** = Possible system damage



: **Danger** = Possible injury

General Information

This system produces purified water from potable tap water by combining several purification technologies. The product water is generally stored for routine laboratory applications, or can be used to feed an ultrapure system such as a Milli-Q™.

The main system elements are, **figure 1**:

- (A) Control panel
- (B) Pack locking adapter
- (C) Pretreatment pack
- (D) Liquid crystal display
- (E) Indicator lights
- (F) Keypad
- (G) Main on/off switch
- (H) Power socket
- (I) Fuse holder
- (J) Water connections
- (K) Cleaning port plug of reverse osmosis cartridge(s)
- (L) Tank level, female socket
- (M) Label with system details
- (N) Locking clip screws
- (O) Locking clips

Refer to Appendix 3 for additional information concerning Elix UV Lamp.

Operating principle

Tap water initially passes through a **Progard™** pretreatment pack. It is designed to remove particles and free chlorine from the water. In addition, it helps to prevent mineral scaling in hard water areas. The water is pressurized with a pump and then is purified by reverse osmosis (RO). This produces intermediate quality water.

In the Elix systems, the RO product water then passes through an electrodeionisation (E.D.I.) module. This is the final purification stage used to reduce levels of organic and mineral contaminants.

Note: Millipore water systems are designed to stay in operation mode and will perform best as such. The systems should be placed in Standby mode or switched off **ONLY** for maintenance or repairs.

Flow schematic

The simplified flow schematic of your system is shown in the following drawing. Only the key elements are shown.

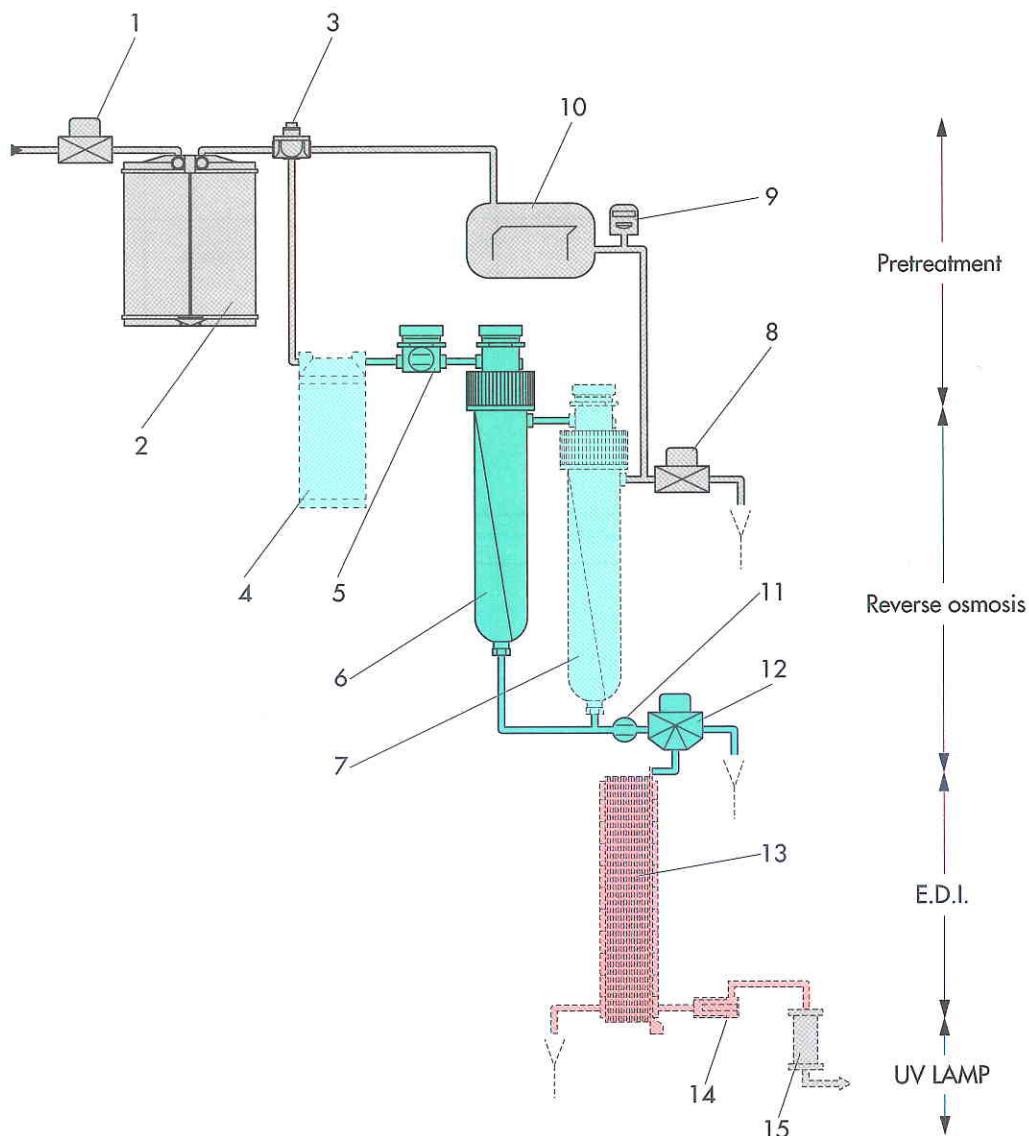

- | | |
|--|----|
| Inlet solenoid valve | 1 |
| Progard pretreatment pack | 2 |
| Pressure regulator | 3 |
| Booster pump | 4 |
| Decontamination port with built in conductivity cell | 5 |
| First reverse osmosis cartridge | 6 |
| Second reverse osmosis cartridge | 7 |
| RO reject solenoid valve | 8 |
| Pressure sensor | 9 |
| RO reject recirculation controller | 10 |
| Conductivity cell | 11 |
| Rinsing valve | 12 |
| E.D.I. module | 13 |
| Resistivity cell | 14 |
| UV Lamp | 15 |

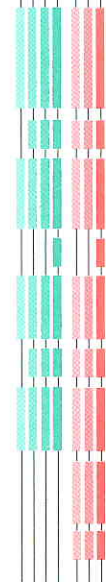

Electrical specifications

Voltage	Power	Frequency	Main fuse	Tank level connector	Digital interface
230 Volts 120 Volts	70 VA 70 VA	50 Hz 60 Hz	1.0 A T 2.0 A T		
230 Volts 120 Volts	80 VA 80 VA	50 Hz 60 Hz	1.0 A T 2.0 A T		
				1 - 4 Volts	RS 232 Connector type RJ 11

Water connections

Feed water connection	1/2" NPT female
Feed water tubing	8 mm outer diameter (OD), length: 2 m. maximum
Drain tubing	8 mm and 6 mm OD, length: 2.5 m. maximum
Product water tubing	6 mm OD, length: 2.5 m. maximum
Drain capacity	120 litres per hour
Feed water pressure	Minimum : RiOs 3 : 3.5 bar (50 psi) at 120 L/H RiOs 5/8/16 : *2.0 bar (30 psi) at 120 L/H Elix 3/5/10 : *2.0 bar (30 psi) at 120 L/H Maximum : All systems : 6.0 bar (90 psi)

* Call Millipore Technical Service if the Tap water pressure is below 2.0 bar (30 psi) at 120 L/H

Feed water

Total Dissolved Solids	RiOs 3 : < 1500 $\mu\text{s}/\text{cm}$ Other systems : < 2000 $\mu\text{s}/\text{cm}$
Temperature	2 - 35 °C (35.6 - 95 °F)
Iron	< 0.1 ppm as CaCO_3
Aluminium	< 0.05 ppm as CaCO_3
Manganese	< 0.05 ppm as CaCO_3
pH	4 - 10
CO_2	< 30 ppm
Fouling index	Progard 1 : < 5 Progard 2 : < 12
Total chlorine	Progard 1 : < 1 ppm Progard 2 : < 3 ppm

Note: The pretreatment packs have been developed to be fed with potable water meeting the specifications above. Additional pretreatment by activated carbon or prefiltration may be necessary when these levels are exceeded or due to specific local water characteristics. **Call Millipore Technical Service for additional information.**

Environment

Storage and operating temperature	5 °C < T < 40 °C
Humidity	20 % - 80 % without condensation
Altitude	< 2000 meter

Performance

Ionic rejection Typ. - Min.	Rejection of particles	Rejection of micro-organisms	Rejection of organics	*Silica	*Resistivity	TOC
97 % - 94 %	> 99 %	> 99 %	> 99 % for MW >100	-	-	-
97 % - 94 %	> 99 %	> 99 %	> 99 % for MW >100	> 99.9 % rejection	10-15 MΩcm	< 30 µg/Litre (ppb)

* Feed water [CO₂] ≤ 20 ppm: Product resistivity 10 - 15 MΩcm , 99.9 % silica rejection.

* Feed water [CO₂] ≥ 20 ppm but ≤ 30 ppm: Product resistivity 5 - 10 MΩcm , 99.7 % silica rejection.

	RiOs 3	RiOs 5	RiOs 8	RiOs 16
Nominal permeate flow rate	2.5 LPH at 7°C 9.0 LPH at 30°C (3.5 bar pressure)	5 LPH	7.5 LPH	15 LPH
Nominal Reject flow 7°C < T < 30°C	42 LPH (3.5 bar pressure)	15 LPH Constant	20 LPH Constant	25 LPH Constant
Noise level in dB A at 1 metre	44.5	44.5	44.5	44.5

	Elix 3	Elix 5	Elix 10
Nominal product flow rate 7°C < T < 30°C	3 LPH Constant	5 LPH Constant	10 LPH Constant
Reject flow rate	17 LPH Constant	23 LPH Constant	31 LPH Constant
Noise level in dB A at 1 metre	44.5	44.5	44.5

Dimensions and weight

Height	455 mm
Width	255 mm
Depth	355 mm (including wall mount projection)
Operating weight	
RiOs 3	11.5 kg
RiOs 5	14 kg
RiOs 8	14 kg
RiOs 16	15 kg
Elix 3	15 kg
Elix 5	15 kg
Elix 10	16 kg

Unpacking

The different components supplied with the system are shown in figure 2 and are listed below.

		Present	
		yes	no
(A)	Water purification system		
(B)	Power cord		
(C)	Folder and documents		
(D)	Feed and reject water tubing 8 mm OD, 6 metres length		
(E)	6 mm OD tubing for:		
	- Product water		
	- E.D.I. reject water		
(F)	Adapter 1/2" FNPT - 8 mm tubing with integrated screen filter		
(G)	Teflon™ tube		
(H)	Pack of elbow fittings		
(I)	Slot long plugs		
(J)	Progard pretreatment pack (ordered separately)		

Observed by _____
Name Signature Date

Verified by _____
Name Signature Date

Installation of the system



The system can be placed on a bench or fixed to a wall. In the case of wall mounting, verify that the wall is able to support the operating weight of the system.

Contact Millipore Technical Service Dept. to carry out the wall mounting of the system.

The area around the system needs a number of different connections necessary for proper functioning of the system. The system is generally linked to a reservoir. Figure 3 shows the different connections to make to the system.

Connection of feed water to the system (Figure 4)

1. Close any valve(s) supplying feedwater to the system (valve not included with system).
2. Cut the feed water tubing, 8 mm OD (C) to the desired length (< 2 metres).
3. Remove the protective plug (B) from "FEED 1" connection (H) by pressing on collar (A) and pulling plug.
4. For wall mounting of the system, install elbow connectors (figure 2, H).
5. Connect the feed water tubing (C) (8 mm OD) to inlet "FEED 1" by inserting it firmly in the fitting. Verify that the connection is correctly made by pulling several times on the tubing. It should not come loose if pulled.
6. Connect the tubing to the feed water supply.
The feed water valve or the fitting (D) should terminate in a 1/2" male fitting.
The 1/2" female fitting (E) is screwed on to the fitting (D). Use the teflon tape which is supplied with the unit to ensure a good seal against leaks.

Connection of the reject tubing (Figure 4)

The procedure to connect the reject tubing is the same as that used for the feed water tubing.

1. Connection of the reject tubing of the RO cartridge(s) 8 mm OD, < 2.5 m is made to the "DRAIN 3" (I) outlet.
2. Connection of the E.D.I. module reject tubing, 6 mm, < 2.5 m is made to the "OUT 5" (J) outlet.

Connection of the product water outlet (Figure 4)

The procedure for connecting the product water tubing is the same used for the feed water tubing.

1. The connection of the product water tubing 6 mm, < 2.5 m is made to the outlet "PRODUCT 2" (K).



When starting up the system, place all the ends of the tubing to a drain.

Installation of the Progard pretreatment pack (Figure 5)

1. Lift the pack adapter cap (A) to the high position and remove the protective plugs (B).
2. Install the Slot Long plugs, (figure 2, I)
(I, 1) for Progard 1
(I, 2) for Progard 2
3. Remove the protective plugs (C) from the Progard pack, and wet the pack o-rings using a few drops of clean water.
4. - Slide the pack onto the metal guide pin.
- Lift up the pack slightly in order to push the bottom of the pack into the slot at the bottom of the system.
- At the upper adapter (D), push the pack completely in until secure.
5. Lock the pack in place with the metal locking clip (E) on the end of the metal guide pin.
6. Bring the adapter cap down to its low position (F).

Note: The position of the pack adapter can be changed depending upon the type of Progard pack being used. **Contact Millipore Technical Service** for assistance with changing the pack adapter position.

System electrical connection

1. Push the reservoir float switch phono jack into the socket at the back of the system (figure 4, L)
2. Using the supplied electrical power cord, connect it to the system and then to an earth grounded outlet (figure 4, M).

Note: **Contact Millipore Technical Service** to carry out the connection to a different type of reservoir.

Connection of a printer to the RS 232 outlet of the system

Your system has the capability to send information which appears in the "MEASURE" menu, to a printer. For all other information related to the connection of a printer to the water system, **contact Millipore Technical Service**.

Operating modes

Your system has a number of operating modes which can be activated via the keypad. Other modes are automatically activated by the microprocessor.

These different modes are displayed on the screen, and are described below:

Routine displays

Operating Mode	Activation	Status of system
STANDBY	Press OPERATE / STANDBY for 2 seconds while the system is in production mode.	The system goes into STANDBY mode but will automatically carry out periodic flush cycles.
PRES.: BAR	Automatic	The system displays the pressure applied to the RO cartridge(s).
OPERATE	Automatic	Water production is temporarily suspended while the system carries out one of the automatic cycles (flush, etc.) Production will restart at the end of the cycle.
FLUSH	Automatic	Automatic flushing of the reverse osmosis cartridge(s).
RINSING	Automatic	Diversion to drain of poor quality RO product water until optimum quality is reached.
TANK FULL ■ 99 %	Automatic	The system goes into TANK FULL mode, since the reservoir is full.
■ 50 %	Automatic (continuous display)	Displays the water level (in % full) in the storage tank.
SYST. RINSE: 239 mn	Press MENU for 2 seconds. Press MENU a second time.	This cycle carries out a system rinse when a new RO cartridge is installed.

Additional displays

Maintenance of the system

Operating Modes	System status	Activation
START AUTOCLEAN	A cleaning of the reverse osmosis cartridge(s) is needed.	Automatic See MAINTENANCE chapter, page 23
EXCHANGE PACK	The pack life has been used up.	Automatic See MAINTENANCE chapter, page 24
EXCH. TANK FILTER	The vent filter or the reservoir needs replacement	Change the vent filter
Cl ₂ CLEAN:	Reverse osmosis cartridge(s) cleaning programme. (duration 15 min.)	Manual See MAINTENANCE chapter, see "use of keypad", page 25
pH CLEAN:	Supplementary cleaning program for reverse osmosis cartridge(s). (Duration is 90 min.)	Automatic See TROUBLESHOOTING chapter, page 26
CHECK PUMP	The pump performance is below specifications.	

Note: The "SERVICE" indicator LED flashes when the system displays one of the above messages.

Alarm displays

Displays	Status of system
PACK NOT IN PLACE	The system is stopped, because the pretreatment pack is not correctly installed. See routine maintenance chapter, "Replacement of Progard pretreatment pack", page 24.
LOW PRESSURE	The feedwater pressure is too low. See TROUBLESHOOTING, page 26.
REJECTION < S.P.	The ionic rejection of the RO cartridge is below the preset acceptable value. See TROUBLESHOOTING, page 26.
PRODUCT < S.P.	The resistivity of the product water from the E.D.I. module is below the preset acceptable value. See TROUBLESHOOTING, page 26.
RS 232 ERROR	Problem with the RS 232 outlet. See TROUBLESHOOTING, page 26.
ERROR NUMBER	Troubleshooting code. Each code corresponds to a different type of problem. See TROUBLESHOOTING, page 26.

Note: The "ALARM" light flashes when the system displays one of the above messages

Use of the keypad

The keypad allows the user to either activate the different operating modes or to review information about system performance.

KEYPAD	ACTION	DISPLAY
--------	--------	---------

Standby and production

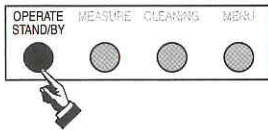

Press the OPERATE/STANDBY button for two seconds.
The system moves between STANDBY and OPERATE modes.

: STANDBY

```
STANDBY 55%
```

and: OPERATE

```
PRES: 5.2BAR 55%
REJECTION: 98.0%
```

Operating data

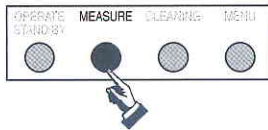

During OPERATE mode:

Pressing the MEASURE button the first time displays
Successive pressing of this button scrolls through the following displays
↓

```
PRES: 5.0BAR 55%
RO FEED 1200µS
```

Second touch
↓

```
PRES: 5.0BAR 55%
PERMEATE: .5µS
```

Third touch
↓

```
PRES: 5.0BAR 55%
PRODUCT: 14.5MΩcm
```

Fourth touch
↓

```
PRES: 5.0BAR 55%
REJECTION: 98.0%
```

Fifth touch

```
PRES: 5.0BAR 55%
TEMP.: 15.0°C
```



The CLEANING function is described in the MAINTENANCE SECTION, cleaning the RO cartridge(s), page 23.

KEYPAD

ACTION

DISPLAY

Menu function

The following menus can be reviewed

Pak life

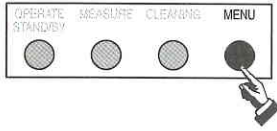

In OPERATE mode:
Press 2 sec. on the **MENU** button
↓

SERVICE:LIFETIME
PAK LIFE 25 DAYS

Choice of display language

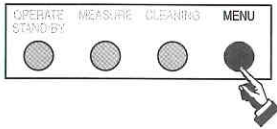

Press **MENU** button
(The MEASURE and CLEANING buttons enable the selection of the display language)
↓

SERVICE:OPTIONS
LANGUAGE ENGLISH

Activate/Deactivate ALARM signal

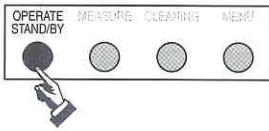

Press **OPERATE/STANDBY**
(The MEASURE and CLEANING buttons allow activation and deactivation of the alarm)
↓

SERVICE:OPTIONS
EXT.ALARM: OFF

Choice of measurement units

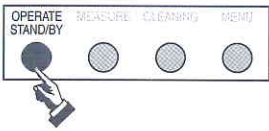

Press **OPERATE/STANDBY**
(The MEASURE and CLEANING buttons enable the selection of units)

SERVICE:OPTIONS
PRES.UNIT: psi

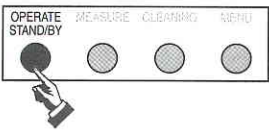

Press **OPERATE/STANDBY**
(The MEASURE and CLEANING buttons enable the selection of units)
↓

SERVICE:OPTIONS
PROD.UNIT: Mdc m

System rinse

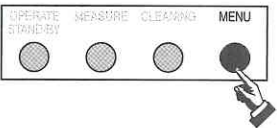

Press **MENU**
The cycle starts automatically after a 10 sec. delay.
↓

SERVICE:FUNCTION
SYSTEM RINSE

Printer

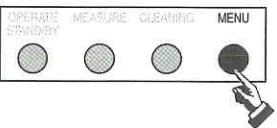

Press **MENU**
One press of the MEASURE button starts printing
↓

SERVICE:PRINTER
PRESS "MEASURE"

Return to main menu

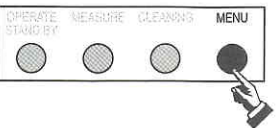

Press **MENU**

PRES:5.2BAR 55%
REJECTION: 98.0%

Start up of the system

With the Progard pretreatment pack in place, and all fluid and electrical connections made, system start up is done as follows:

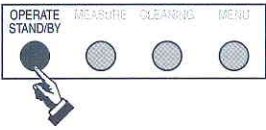
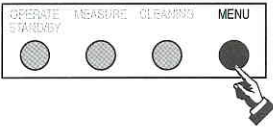
KEYPAD	ACTION	DISPLAY
	1) Open the feed water isolating valve ↓	
	2) Switch on power to the system by moving switch (figure 1, G) to position I	
	Automatic display type of system and serial number for 10 seconds. (Note serial number in the table on page 29)	ELIX 10 VI.00 SR.N° Z7AL568A5C
	Display of operating mode ↓	STANDBY 100% FLUSH
	If the ALARM light is lit and the following message displayed, restart the system as follows: ↓	LOW PRESSURE 100%
	Press 2 seconds on OPERATE/STANDBY Note: Repeat this action if the unit goes back into "LOW PRESSURE" mode (If the message persists, contact Millipore Technical Service) ↓	OPERATE 100% FLUSH
	3) System rinsing required (Duration: 4 hours)	
	Press 2 seconds on MENU button ↓	SERVICE:LIFETIME PAK LIFE: 55DAYS
	Press twice on MENU button ↓	SERVICE:FUNCTION SYSTEM RINSE
	Cycle will activate after a 10 second delay, and will display a countdown of remaining time in rinsing cycle.	OPERATE 55% SYST.RINSE 239mn

Note: At the end of the SYSTEM RINSE cycle, the water purification system will automatically go into **PRODUCTION** mode.
Continue the start-up while the equipment is in this mode.

KEYPAD	ACTION	DISPLAY
--------	--------	---------

4) **Choice of displayed language** (English is programmed as the default)

Note: All information in the "SERVICE" menu is displayed in English only.

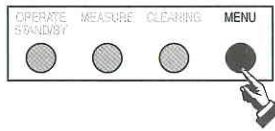

First press 2 seconds on **MENU**

```
SERVICE:LIFETIME
PAK LIFE:55 DAYS
```

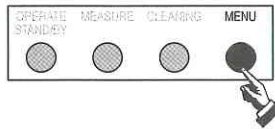

Press **MENU** button a second time

```
SERVICE:OPTIONS
LANGUAGE:ENGLISH
```

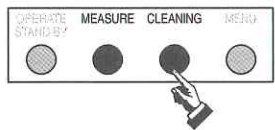

Successive pressing of the **CLEANING** button allows the user to scroll through available languages until desired language is displayed.

```
SERVICE:OPTIONS
LANGUE:FRANCAIS
```

Note: Pressing the **MEASURE** button will skip back to previous language

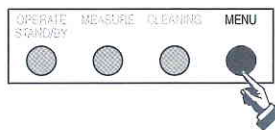

Pressing 2 seconds on **MENU** will validate language choice, and return to initial position.

```
STANDBY 55%
SYST.RINSE:238mn
```

5) **Choice of measurement unit: Bar, psi or kPa** (Bar is programmed as default position)

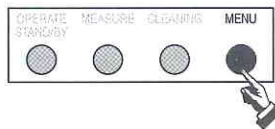

Press 2 seconds on **MENU**

```
SERVICE:LIFETIME
PAK LIFE:55 DAYS
```

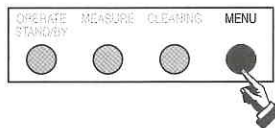

Press on **MENU** button a second time

```
SERVICE:OPTIONS
LANGUAGE:ENGLISH
```

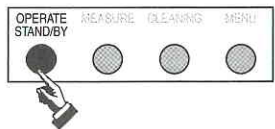

Press twice on **OPERATE/STANDBY** button

```
SERVICE:OPTIONS
PRES.UNIT bar
```

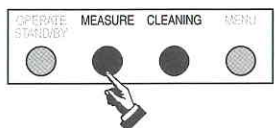

One press on **MEASURE** or **CLEANING** button allows the choice of display unit

```
SERVICE:OPTIONS
PRES.UNIT psi
```

```
SERVICE:OPTIONS
PRES.UNIT kPa
```

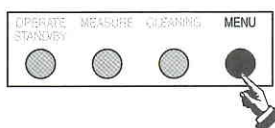

Press 2 seconds on **MENU** to validate units and to return to start

```
STANDBY 55%
SYST.RINSE:232mn
```

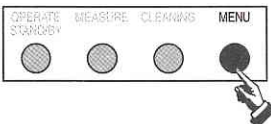
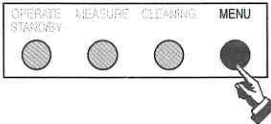
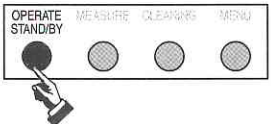
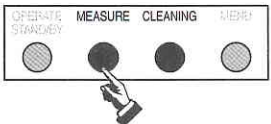
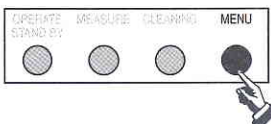
KEYPAD	ACTION	DISPLAY
	Press once on MENU button for 2 seconds ↓	SERVICE:LIFETIME PAK LIFE:55 DAYS
	Press a second time MENU button ↓	SERVICE:OPTIONS LANGUAGE:ENGLISH
	Press three times on OPERATE/STANDBY ↓	SERVICE:OPTIONS PROD.UNIT MΩcm
	Pressing MEASURE or CLEANING enables selection of measurement unit	SERVICE:OPTIONS PROD.UNIT μs
	Press on MENU button for 2 seconds to validate units and to return to start position	STANDBY 55% SYST.RINSE:232mn

Note: The system will reach its optimal performance after 2-3 days from start-up. At this time (2-3 days), complete the table on page 29.

7) How to set the time of the day and the date

The date (day-month-year) can be printed out or downloaded to a computer along with other operating data pertinent with the Elix. The date is changed at midnight each day. The time of the day is not printed out or downloaded to a computer; it is used only to advance the date.

Follow the steps below to change the Time Of the Day or the Date.

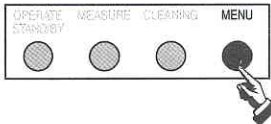
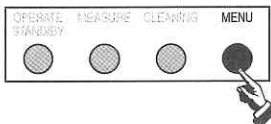
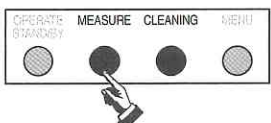
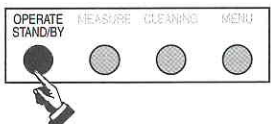
	Press the MENU keypad button for about 2 seconds. The LCD will change as shown here.	SERVICE:LIFETIME PAK LIFE: DAYS
	Press the MENU keypad button (4 times) until the CALENDAR screen display appears.	CALENDAR: 20:30 FRI/JAN - 20/00
	The Hour will be flashing. Change the Hour by using the MEASURE or CLEANING Keypad buttons.	CALENDAR: 20:30 FRI/JAN - 20/00
	Press the OPERATE/STANDBY keypad button to validate (select) the Hour. The Minutes will now be flashing.	CALENDAR: 20:30 FRI/JAN - 20/00

Repeat the two steps above to change the Day-Of-Week, the Month, the Date and the Year. When you are finished, press **MENU** button for more than 2 seconds to go back to STANDBY mode.

Installation of the standard reservoir from Millipore

Unpacking the reservoir

There are several items included with the reservoir. These are shown in figure 3 and are listed below:

- (A) Level sensor for reservoir
- (B) Overflow tubing with airgap
- (C) Valve for draining reservoir or feeding a Milli-Q
- (D) Fitting for connection to fill reservoir
- (E) Valve for drawing water from the reservoir
- (F) Tubing: 5 metres (16.4 ft) length, 6 mm ID

- (G) Not included: Vent filter, (catalogue number TANKMPK01)

Note: The reservoir can be fitted with a vent filter. This prevents contamination of the reservoir water by airborne particles or solvent fumes. The reservoir should be fitted with a length of overflow tubing to prevent flooding or spills. A level sensor (electric) can be used to display the amount of water in the reservoir. The level sensor will only work with RiOs or Elix systems.

Reservoir	Operating Weight
30 l	34 kg
60 l	62 kg

Installation (see figure 3)



The reservoir can be either set up on a flat surface or wall mounted. In the case of wall mounting, make sure the wall will support the weight of a full reservoir. Follow the procedure delivered with the reservoir for the wall mounting of the reservoir.

1. Connect the level sensor (A) to the water purification system (figure 4, L).
2. To insure proper operation of the reservoir overflow, position the air gap in a vertical position (red check valve at the top).
Place the end of the overflow into a drain. Refer to figure 3, B if necessary.
3. If the reservoir water is feeding another system, then connect a length of tubing (F) between one of the outlet valves (C) and the other system.
4. Connect a length of tubing between PRODUCT 2 (figure 4, K) and the tank inlet fitting (D).
5. Make sure the reservoir valve (E) is closed. It can be used to get water directly from the reservoir.
6. Screw the vent filter (G) to the top of the reservoir.

Note: In order to not exceed the capacity of the vent filter, it is recommended to replace it at the same time that the Progard pre-treatment pack is replaced.

On a periodic basis, verify that the reservoir overflow does not contain water. If there is water in the overflow tubing, drain it by removing the tubing from the red check valve.

MILLIPORE ELIX SYSTEM

ROs Elix
3 5 816 3 510

Routine maintenance

Monthly	Every 6 months	Following display of message on system
Note the operating parameters as indicated in table on page 29	Clean the screen filter. See ROUTINE MAINTENANCE on page 24	Display: START AUTOCLEAN Carry out a cleaning of the RO cartridge(s). See below Display: EXCHANGE PAK Replace the pretreatment pack. See ROUTINE MAINTENANCE, page 24

Periodic maintenance

Cleaning of the reverse osmosis cartridge(s)

1. Place the system in STANDBY mode by pressing OPERATE/STANDBY for 2 seconds. The STANDBY display flashes to indicate the depressurization of the system.
2. Once the STANDBY display stops flashing, unscrew the sanitization port plug (figure 1, K) and drop in a chlorine tablet.
3. Replace the sanitization port plug. Screw in hand tight, without forcing.
4. Start the cleaning cycle as follows:

Press two seconds on **CLEANING**

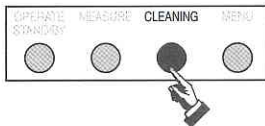

Chlorine cleaning cycle validated after 10 second delay. Countdown of time remaining in cycle



STANDBY 55%
CL₂ CLEAN

STANDBY 55%
CL₂ CLEAN 14 mn

At the end of this cycle the system switches automatically to OPERATE mode, in order to fill the reservoir of necessary.

Replacement of Progard pretreatment pack (figure 5)

1. Place the system into STANDBY mode by pressing the OPERATE/STANDBY button for 2 seconds. The STANDBY display flashes to indicate depressurization of the system.
2. Once the STANDBY display stops flashing
 - bring the pack adapter cover to the top position (A)
 - remove the locking clip (E)
 - pull out the Progard pack.
3. Install the new Progard pack as described in the "INSTALLATION" chapter, page 13.

Cleaning screen filter (figure 4)

1. Close the feed water isolating valve.
2. Disconnect the feed water tubing (C) from the system and from fitting (F).
3. Unscrew fitting (F) from fitting (E). Locate the screen filter (G).
4. Clean the screen filter (G).
5. Carry out these steps in reverse order to reassemble screen filter.

Additional cleaning of the reverse osmosis cartridge(s)

1. Place the system in STANDBY mode by pressing the OPERATE/STANDBY button for 2 seconds. The STANDBY display flashes to indicate depressurization of the system.
2. Once the STANDBY display stops flashing, unscrew the sanitization port plug (figure 1, K) and add the ROCLEAN-A or ROCLEAN-B cleaning pouch.
3. Replace the sanitization port plug.
4. Start the additional cleaning cycle as follows:



Press 2 seconds on **CLEANING**

STANDBY 55%
CL₂ CLEAN

Press once on **CLEANING**

STANDBY 55%
pH CLEAN

The pH cleaning cycle will start after a 10 second delay. Countdown of time remaining in cycle will be displayed.

STANDBY 55%
pH CLEAN 89 mn

At the end of this cycle the system returns to the mode it was in prior to the start of the cleaning cycle (STANDBY)

To enable filling of the reservoir,

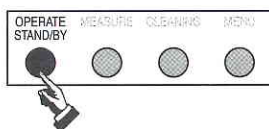

Press 2 seconds on **OPERATE/STANDBY** to have the following display

OPERATE 55%
pH CLEAN 14 mn

Maintenance Messages

When the SERVICE LED is flashing, a corresponding message is displayed on the LCD. Use the table below to see the cause and appropriate action to follow:

STATE/MESSAGE	CAUSE	ACTION
Display black. No LED's No electrical power	- Power cord loose. - Blown fuse.	Check main electrical power. Check power cord. Check or change main fuse See APPENDIX 2.
START AUTOCLEAN	An RO membrane cleaning is needed.	Perform an autocleaning See chapter MAINTENANCE.
EXCHANGE PACK	The Progard pretreatment pack needs replacement.	Replace Progard. See chapter MAINTENANCE.
LOW PRESSURE	Feedwater pressure too low. Progard pack plugged. Inlet solenoid valve not opening.	Check feedwater pressure. Change Progard. Call Millipore Technical Service.
REJECTION < S.P.	RO Rejection below set point.	Clean RO membrane(s). See chapter MAINTENANCE. If condition persists, call Millipore Technical Service.
PRODUCT < S.P.	Elix product water resistivity below set point.	If condition persists, call Millipore Technical Service.
PAK NOT IN PLACE	Progard pretreatment pack loose or not secure.	Reinstall Progard pack. See Chapter MAINTENANCE.
CHECK PUMP	Pump not operating within specifications.	Call Millipore Technical Service.
ERROR NUMBER	Error number displayed corresponds to a detected system error.	Errors listed on page 27.
RS232 ERROR	A transmission error occurred while sending information to a printer.	Reinitialize the system by pressing OPERATE/STANDBY. If condition persists, call Millipore Technical Service.

Error codes

When the ALARM LED is flashing, an error code simultaneously appears on the LCD. Each error code number corresponds to a specific problem.

Error code	MEANING	WHY ? WHAT TO DO ?
1	Elevated motor voltage.	Call Millipore Technical Service.
2	Low motor voltage.	Call Millipore Technical Service.
3	Elevated system pressure.	Call Millipore Technical Service.
4	E.D.I. module error. Electrical Current error. Current is too high, or is zero.	Call Millipore Technical Service.
5	E.D.I. module error. Electrical Voltage error. Voltage is too high, or is zero.	Call Millipore Technical Service.
6	Temperature < minimum.	If the message persists, call Millipore Technical Service.
7	Temperature > maximum.	If the message persists, call Millipore Technical Service.
8	Feed water conductivity < minimum (not measureable).	Water conductivity too low, call Millipore Technical Service.
9	Feed water conductivity > maximum (off scale).	Water conductivity too high, call Millipore Technical Service.
10	RO permeate conductivity < minimum (off scale).	RO permeate conductivity too low. If the message persists, call Millipore Technical Service.
11	RO permeate conductivity > maximum (off scale).	RO permeate conductivity too high. If the message persists, call Millipore Technical Service.
12	Product resistivity < minimum (off scale).	E.D.I. product resistivity too low. If the message persists, call Millipore Technical Service.
13	Product resistivity > maximum (off scale).	E.D.I. product resistivity too high. If the message persists, call Millipore Technical Service.
14	Reference value error in electronic measurement circuit.	Call Millipore Technical Service.
15	Storage error in EEPROM memory chip.	Call Millipore Technical Service.

Feed water conductivity measurement

The system recycles a portion of the water from the RO reject stream. The conductivity of the feed water which is displayed on the unit will therefore be slightly higher than the incoming tap water. To know the exact value of the tap water conductivity proceed as follows:

1. During normal production mode, switch off power to the system for a few seconds by switching main switch (figure 1, G) from position I to position O. At startup, the system will automatically carry out a 3 minute rinse. During this time, since there is no recycle of reject water, the true feed water conductivity can be displayed.

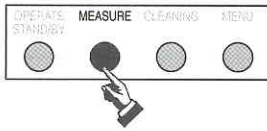

Press 2 seconds on **MEASURE**

OPERATE : 55%
RO FEED 74.5µs

At the end of this 3 minute cycle, the system comes back to **OPERATE** mode

Pressure regulator adjustment verification

In normal operating mode, the system displays the pressure applied to the RO cartridge by the pump. The pressure regulator is adjusted to 2 bar and can be verified in the following way:

1. Place the system in **STANDBY**, by pressing 2 seconds on the **OPERATE/STANDBY** button. The **STANDBY** display flashes to indicate depressurisation of the system.
2. When the **STANDBY** display remains steady (stops flashing), press the **MEASURE** button. The pressure displayed after a few seconds is the **pressure applied after the pressure regulator**.

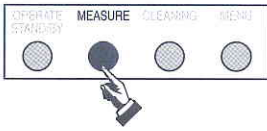

At the end of this 10 second cycle, the system comes back to the mode which was active prior to the cycle (**STANDBY**)

PRES: 2.0BAR 55%

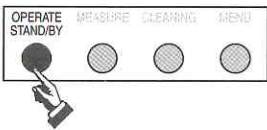

Press two seconds on **OPERATE/STANDBY** to start the system

PRES: 5.0BAR 55%
REJECTION: 98.0%

If the pressure needs to be adjusted, please contact Millipore Technical Service.

Prolonged shutdown of the system

Place the system in **STANDBY** mode when purified water production is not needed. **In case of complete shutdown, please contact Millipore Technical Service.**

***System information N°** _____

Type of system	R _____
	Serial N° _____

Pressure regulator adjustment	RO Pressure	Feed water conductivity	RO permeate conductivity

Water temperature	RO rejection (%)	RO reject flowrate	RO permeate flowrate

E.D.I. concentrate flowrate	E.D.I. product flowrate	E.D.I. product resistivity	Other

Comments _____

Measured by _____

Name

Signature

Date

Verified by _____

Name

Signature

Date

* Make a copy of this information. Keep one copy with this manual and locate the other copy near the water purification system.

Replacement of the reverse osmosis cartridge(s)

The cabinet of the system needs to be removed. If the system is wall mounted, unhook the system from its support screws.



1. Put the system in STANDBY mode by pressing for 2 seconds on OPERATE/STANDBY.
2. Switch off power to the system by switching the main switch (figure 1, G) to position 0.
3. Unplug and disconnect the system main electrical power cord.
4. Unscrew and remove the cleaning port plug (figure 1, K).
5. Unscrew the two screws on the lower locking clips (figure 1, N).
6. Slide the two clips backwards (figure 1, O) to unlock the cabinet.
7. Lift up the cabinet slightly, disconnect the ground wire and remove the cabinet.
8. Mark the inlet and outlet tubes on the RO cartridge(s) and the connections. (Figure 7, A). Disconnect tubes.
9. Remove the locking ring(s) from the RO housing (s) (Figure 7, B).
10. Unscrew the housing head (Figure 7, C) by placing it in the opening (figure 7, D) and replace the cartridge(s).
11. Follow the above instructions in reverse order to reassemble the unit.
12. Start a system rinse cycle (see page 19).

Start up of a Progard pretreatment pack of a different size

The system cabinet should be removed. In the case of a wall mounted system, unhook the system from its support screws.



1. Put the system in STANDBY mode by pressing 2 seconds on OPERATE/STANDBY.
2. Switch off power to the system by switching main switch (figure 1, G) to position 0.
3. Unplug and disconnect the system main electrical power cord.
4. Unscrew and remove the cleaning port plug (figure 1, K).
5. Unscrew the two screws on the lower clips (figure 1, N).
6. Slide the two clips backwards (figure 1, O) to unlock the cabinet.
7. Lift up the cabinet slightly, disconnect the ground wire, and remove the cabinet.
8. Remove the plug in strips (figure 5, G) and adjust the position of the pack adapter using the new pack as a guide.
9. Place the new plug in strips in position.
10. Follow above instructions in reverse order to reassemble the unit.

Interruption of a cleaning or rinsing cycle on the RO cartridge(s)

If a cleaning or rinsing cycle has been started after introducing a cleaning agent into the system, it is very important to complete the cycle in order to insure a complete rinsing of the system. The cycle can be cancelled with no ill effect, if a cleaning agent has not been introduced.

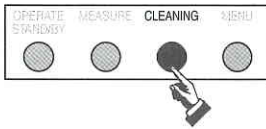

Press 10 seconds on **CLEANING** button
↓

STANDBY 55%
CL₂ CLEAN

PRES: 5.0BAR 55%
REJECTION: 98.0%

At the end of this cycle, the system returns to the mode which was active before starting the cleaning cycle.

Replacement of main electrical power fuse

1. Put the system in STANDBY mode by pressing for 2 seconds on OPERATE/STANDBY button.
2. Switch off power by switching the main power switch (figure 1, G) to position 0.
3. Unplug and disconnect the system main electrical power cord.
4. Remove the fuse holder (figure 6).
5. Remove the faulty fuse (figure 6, A) and replace it by a new fuse (figure 6, B).



Note: It is recommended to provide a spare fuse to be kept in the secondary position in the fuse holder.

6. Replace the fuse holder to its original position and reconnect the system.

Additional features

(Software versions V2.06 and higher, V3.00 and higher).

UV LAMP

Elix UV systems have a factory installed 254 nm Germicidal UV Lamp. The UV Lamp is located immediately following the EDI Module and is used to kill bacteria in the product water.

Note: This accessory is optional on RiOs Systems and previous versions of Elix . You need to order an UV Upgrade kit. This has a Millipore Catalogue Number of ZLXU VLP 01 (see Ordering Information for more details).

1 - UV Age

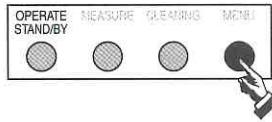

In OPERATE or STANDBY mode: Press 2 sec. on the MENU button. When you see the "SERVICE: LIFETIME" message on the display, press the **OPERATE/STANDBY** button once to see the lifetime of the UV Lamp.

SERVICE: LIFETIME
UV AGE 1 MONTHS

Note: the value shown decreases by a month at a time.

2 - Maintenance Messages (SERVICE LED-orange): message and service LED are flashing.

STATE/MESSAGE	CAUSE	ACTION
EXCHANGE UV LAMP	The UV Lamp needs replacement.	Call Millipore Technical Service.

OPERATE :
EXCHANGE UV LAMP

3 - How to replace the UV Lamp

When "EXCHANGE UV LAMP" appears on the display, the UV Lamp needs to be replaced. It is recommended to have a **Millipore Field Service Representative** change the UV Lamp.

TEMPERATURE MEASUREMENTS

1 - Product Water Temperature: the temperature of the product water exiting the system.

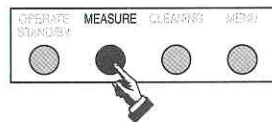

PROD. TEMP.: during OPERATE mode: press on the **MEASURE** button several times until the PROD. TEMP. is shown.

PRES: 5.0BAR 55%
PROD TEMP 20.0°C

2 - Feed Temperature: the temperature of the water entering the system.

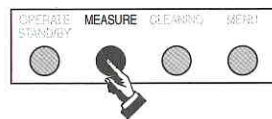

FEED TEMP.: during OPERATE mode: press on the **MEASURE** button several times until the FEED TEMP. is shown.

PRES: 5.0BAR 55%
FEED TEMP 15°C

OTHER SPECIFICATIONS

1 - Materials in Contact of Water

UV Lamp and Housing: Ultrapure Quartz and 316 Stainless Steel

2 - Electrical Specifications

Elix UV:

120 VAC \pm 10%, 90 VA, 60 HZ. 0.75 amp source, 2 A T fuse used.
230 VAC \pm 10%, 90 VA, 50 HZ. 0.39 amp source, 1 A T fuse used.

3 - Additional Product Water Specifications

Please refer to page 10 in this manual for the Product Water Specifications. In addition, Elix and RiOs systems having a UV inside have:

Micro-organisms: \leq 1 CFU/ml (Colony Forming Unit per milliliter) when Feed Water levels are $<$ 100 CFU/ml.

Note: This is the Micro-Organism Specification of the Product Water and may not correspond to the Micro-Organism levels in a storage reservoir receiving this water.

4 - Operating Weight

Elix 3 UV:	15.9 kg
Elix 5 UV:	15.9 kg
Elix 10 UV:	16.9 kg

A

ALARM 16, 18, 19, 27

C

Chlorine 6, 9, 23

CO₂ 9, 10

Connection 2, 9, 12, 13, 22

E

E.D.I. 7, 11, 27, 29

F

FDA 8

Feed water pressure 9

Flow schematic 7

Flush 14

Fouling 9

Frequency 8

Fuse 26, 31

H

Height 10

Humidity 9

K

Keypad 5, 14, 17

L

Language 18, 20

Locking clip 13

LOW PRESSURE 19

M

Main fuse 8

MAINTENANCE 15, 17, 23, 26

Maintenance 26

Maintenance 23

Materials 8

N

Nominal permeate flow rate 10

Nominal product flow rate 10

Nose level 10

NSF 8

O

Overflow 22

P

Pak life 18

Performance 10

Power 6, 8, 1, 26

Pressure 9, 10, 14, 16, 26, 27, 28

Printer 13, 26

Progard 2, 6, 7, 8, 9, 11, 13, 16,

19, 22, 24, 26, 30

Pump 6, 15, 28

R

Reject flow 10

Rejection 10, 16

Reservoir 11, 13, 14, 22, 23, 25

Resistivity 7, 10

ROCLEAN-A 25

ROCLEAN-B 25

S

Screen filter 24

Serial number 19

Shutdown 28

Silica 10

Storage and operating temperature 9

T

Temperature 32

U

Units 18, 20, 21

UV Lamp 32, 33

V

Vent filter 22

Elix / RiOs systems

Reference information for Elix systems:

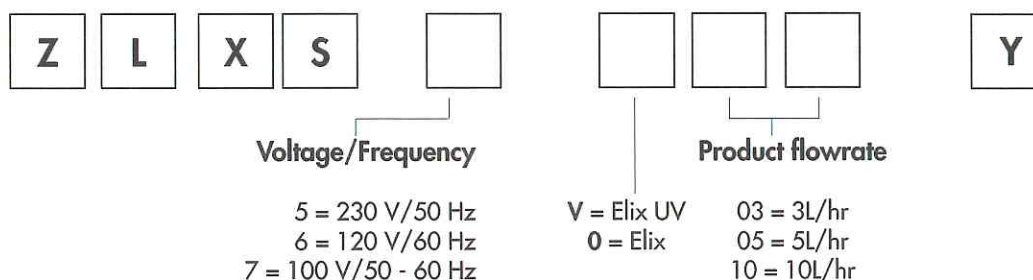

Reference information for RiOs systems:

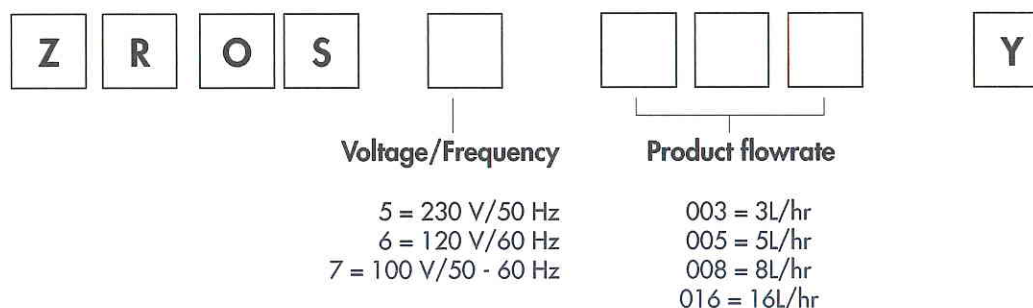

Elix/RiOs System Consumables

Description	Quantity/Pack	Catalogue Number
Progard™ 1 Pretreatment Pack with Reservoir Protection Filter	1	PROG MPK 01
Progard 1 Pretreatment Pack (Bacteriostatic Activated Carbon) with Reservoir Protection Filter	1	PROG MPK S1
Progard 2 Pretreatment Pack (long) with Reservoir Protection Filter	1	PROG MPK 02
Progard 2 Pretreatment Pack (Bacteriostatic Activated Carbon) with Reservoir Protection Filter	1	PROG MPK S2
Progard 1 Pretreatment Pack	1	PROG 000 01
Progard 1 Pretreatment Pack (Bacteriostatic Activated Carbon)	1	PROG 000 S1
Progard 2 Pretreatment Pack (long)	1	PROG 000 02
Progard 2 Pretreatment Pack (Bacteriostatic Activated Carbon)	1	PROG 000 S2
Progard 1 Pretreatment Pack without Polyphosphate	1	PROG ONP 01
Progard 2 Pretreatment Pack without Polyphosphate	1	PROG ONP 02
RO Cartridge (for Elix 3 System, RiOs 3, RiOs 5)	1	CDRC 002 01
RO Cartridge (for Elix 5 System, RiOs 8)	1	CDRC 602 01
RO Cartridge (for Elix 10 System, RiOs 16)	2	CDRC 602 02
PE Reservoir Vent Filter	1	TANK MPK 01
Chlorine Tablets	45	ZWCL 01F 50
RO Clean™ A	12	ZWAC ID0 12
RO Clean B	12	ZWBA SE0 12
UV lamp for Elix UV	1	ZLXU VLP 01

Elix/RiOs System Accessory Items

Description	Catalogue Number
UV Upgrade Kit	ZLXU PGU V1
Wall Mounting Bracket System	SYST FIX 01
Elix Remote Display	ZMQS RMD S1
Bench Integrated Tank with Pump (230 V / 50 Hz)	ZBIT ANK 51
Bench Integrated Tank with Pump (120 V / 60 Hz)	ZBIT ANK 61
Printer Cable	PRNT CBL 01
Computer Cable	COMP CBL 01
Explore Data™ Software	SOFT 000 A1
30-Litre PE Reservoir	TANK PE0 30
60-Litre PE Reservoir	TANK PE0 60
100-Litre PE Reservoir	TANK PE1 00
Wall Mounting Bracket for 30 or 60L Reservoirs	TANK FIX 01
Automatic Sanitization Module (ASM) for PE Reservoir (230 V / 50 Hz)	TANK S50 UV
Automatic Sanitization Module (ASM) for PE Reservoir (120 V / 60 Hz)	TANK S60 UV
ASM with Water Detector (230 V / 50 Hz)	TANK S5L UV
ASM with Water Detector (120 V / 60 Hz)	TANK S6L UV
Water Detector (230 V / 50 Hz)	ZFWA TDE T2
Water Detector (120 V / 60 Hz)	ZFWA TDE T1
Recirculation Pump for PE Reservoir (230 V / 50 Hz)	TANK REC 50
Recirculation Pump for PE Reservoir (120 V / 60 Hz)	TANK REC 60
Remote Dispenser (for Recirculation Loop)	ZMQS POU B1

Millipore Corporation ("Millipore") warrants its products will meet their applicable published specifications when used in accordance with their applicable instructions for a period of one year from shipment of the products. **MILLIPORE MAKES NO OTHER WARRANTY, EXPRESSED OR IMPLIED. THERE IS NO WARRANTY OF MERCHANTABILITY OR FITNESS FOR A PARTICULAR PURPOSE.** The warranty provided herein and the data, specifications and descriptions of Millipore products appearing in Millipore's published catalogues and product literature may not be altered except by express written agreement signed by an officer of Millipore. Representations, oral or written, which are inconsistent with this warranty or such publications are not authorised and if given, should not be relied upon.

In the event of a breach of the foregoing warranty, Millipore's sole obligation shall be to repair or replace, at its option, the applicable product or part thereof, provided the customer notifies Millipore promptly of any such breach. If after exercising reasonable efforts, Millipore is unable to repair or replace the product or part, then Millipore shall refund to the customer all monies paid for such applicable product or part. **MILLIPORE SHALL NOT BE LIABLE FOR CONSEQUENTIAL, INCIDENTAL, SPECIAL OR ANY OTHER INDIRECT DAMAGES RESULTING FROM ECONOMIC LOSS OR PROPERTY DAMAGE SUSTAINED BY ANY CUSTOMER FROM THE USE OF ITS PRODUCTS.**

CONTACTING MILLIPORE

INTERNET

The Millipore Internet Site can be used to find addresses, telephone/fax numbers and other information.

Internet Site Address: www.millipore.com
 www.millipore.com/techservice

MANUFACTURING SITE

Millipore SAS
67120 Molsheim
FRANCE

ADDITIONAL INFORMATION

The following information is in addition to the text found in the manual.

Manufacturing site: MILLIPORES.A.S., 67 120 MOLSHEIM, FRANCE.

SAFETY SYMBOLS FOUND ON THE SYSTEM CABINET OR INSIDE



Danger!



Danger: UV Radiation!



Electrical Danger!



Ground Connection!

Electrical Specifications

	Voltage	System Catalogue Number	Power	Frequency	Main fuse
RiOs	230 Volts ± 10%	ZROS5003Y ZROS5005Y ZROS5008Y ZROS5016Y	70 VA	50 Hz	1.0 A Slo-Blo
	120 Volts ± 10%	ZROS6003Y ZROS6005Y ZROS6008Y ZROS6016Y	70 VA	60 Hz	2.0 A Slo-Blo
Elix	230 Volts ± 10%	ZLXS5003Y ZLXS5005Y ZLXS5010Y	80 VA	50 Hz	1.0 A Slo-Blo
	120 Volts ± 10%	ZLXS6003Y ZLXS6005Y ZLXS6010Y	80 VA	60 Hz	2.0 A Slo-Blo
Elix UV	230 Volts ± 10%	ZLXS5V03Y ZLXS5V05Y ZLXS5V10Y	90 VA	50 Hz	1.0 A Slo-Blo
	120 Volts ± 10%	ZLXS6V03Y ZLXS6V05Y ZLXS6V10Y	90 VA	60 Hz	2.0 A Slo-Blo

Environment

Storage and operating temperature:	$5\text{ }^{\circ}\text{C} < T < 40\text{ }^{\circ}\text{C}$
Humidity:	20 % - 80 % without condensation
Altitude:	< 2000 meters
Installation Category:	II
Pollution Degree:	2

ANNEXE 1

REV.: A

SPEC N° 0 001 692 PS

WALL MOUNTING BRACKET
for
ELIX/RiOs & MILLI-Q SYSTEMS

CAT. # : SYST FIX 01

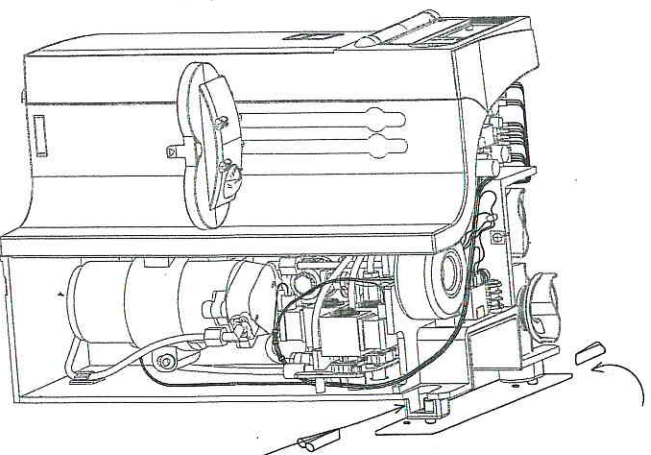
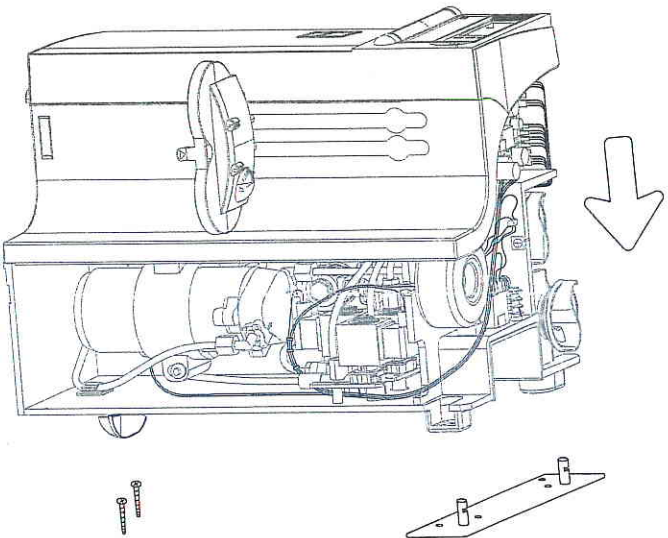
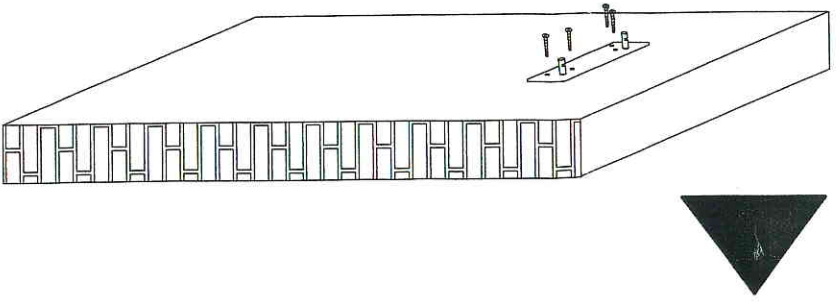

MILLIPORE

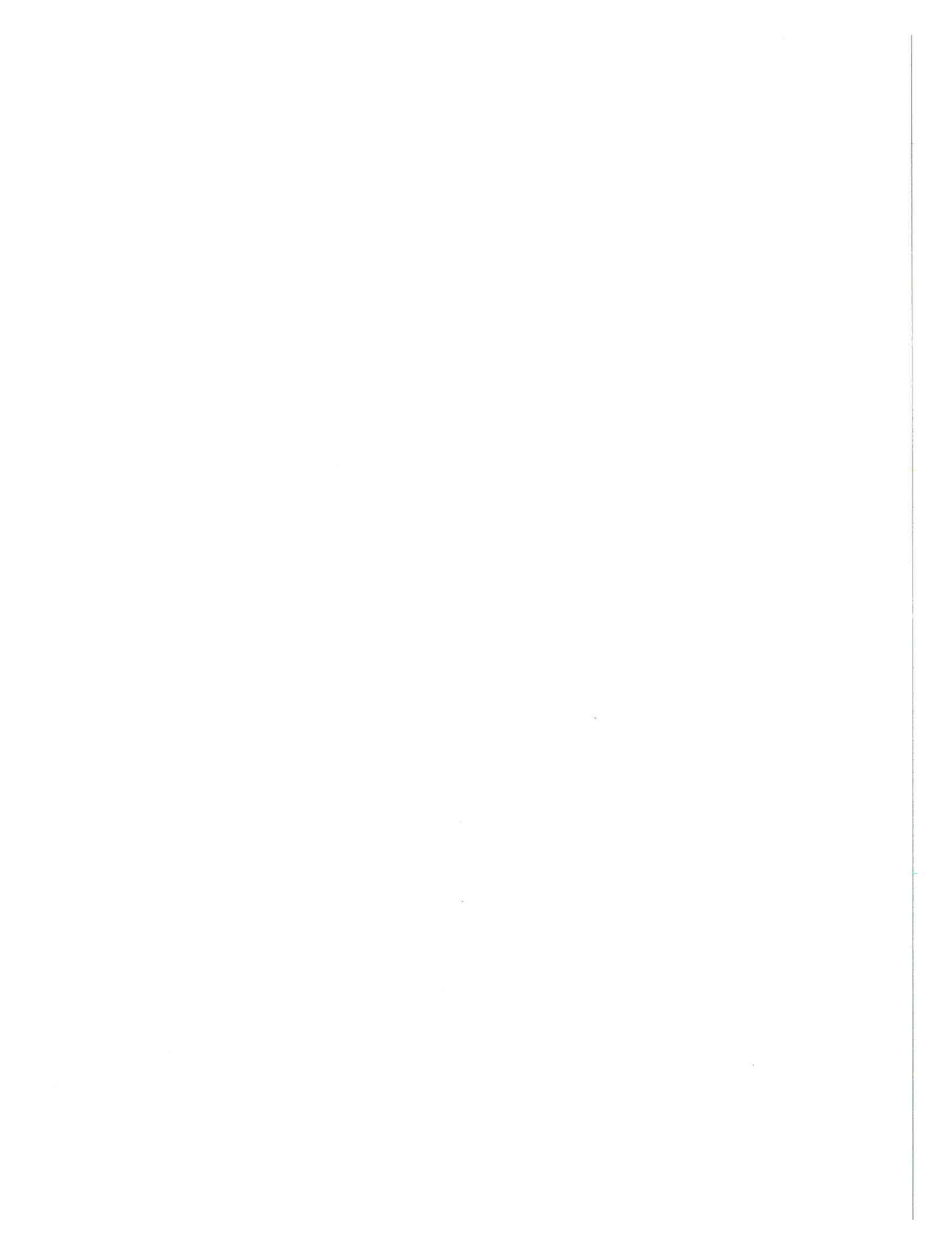

Explication du symbole : "poubelle barrée"
Explanation of the symbol: "crossed bin"



Directive 2002/96/CE : Pour les utilisateurs européens uniquement

Ce symbole « poubelle barrée » sur le produit ou sur son emballage indique qu'il ne doit pas être traité comme un déchet ménager et qu'il devra être amené à un point de collecte pour le recyclage des équipements électriques et électroniques.

En agissant ainsi, vous aiderez à prévenir les conséquences négatives pour l'environnement et la santé de l'être humain, qui pourraient être causées par une gestion inappropriée de ce déchet.

Le recyclage des matériaux aidera à la conservation des ressources naturelles.

Pour une information à propos des systèmes de collecte de ce produit, contactez votre organisme professionnel.

Directive 2002/96 EC : For European users only

The symbol "crossed bin" on a product or its packaging indicates that the product should not be treated like household waste when discarded. Instead the product should be disposed of at a location that handles discarded electric or electronic equipment.

Proper disposal of equipment containing electric or electronic components will help to reduce pollution effects to the environment or to human health. Proper recycling of these products helps in environmental preservation and helps to protect natural resources. For more information about recycling of products containing electric or electronic components, please contact your local recycling representative or organisation.

